



2021

Catalogue

thermal insulating composite systems

Beton  Wood®

Index

general	• introduction to reinforced insulation system Betontherm	pg. 4
	• application areas	pg. 5
	• Betontherm system's product overview	pg. 6
	• Fibertherm ® and CorkPanels natural product overview	pg. 8
	• ecological qualities and the certifications obtained	pg.10
betonwood properties	• cement bonded particle board's characteristics	pg.14
	• thermodynamic and acoustic characteristics of cement bonded particle board	pg.18
	• fire resistance class of cement bonded particle board	pg.18
	• general properties of resistance	pg.19
	• resistance to insects and fungi	pg.21
	• resistance to atmospheric agents	pg.21
	• processing and fixing of BetonWood ® boards	pg.22
	• finishing and painting	pg.23
Products for reinforced thermal insulation system's:		
betontherm systems	• Betontherm ® fiber - BetonWood cement bonded particle board and Fibertherm 160 wood fiber	pg.24
	• Betontherm ® fiber dry - BetonWood cement bonded particle board and Fibertherm dry 110 wood fiber	pg.26
	• Betontherm ® fiber base - BetonWood cement bonded particle board and Fibertherm base 250 wood fiber	pg.28
	• Betontherm ® cork - BetonWood cement bonded particle board and CorkPanels blond cork	pg.30
	• Betontherm ® styr EPS - BetonWood cement bonded particle board and expanded polystyrene 70kPa	pg.32
	• Betontherm ® styr XPS - BetonWood cement bonded particle board and extruded polystyrene 300 kPa	pg.34
• Betontherm ® strong - BetonWood cement bonded particle board and extruded polystyrene 700kPa	pg.37	
installation	• storage & transport	pg.40
	• Betontherm system's installation	pg.41
	• dowel fixing	pg.42
	• joint's reinforcement and skimming	pg.43
	• accessories's installation	pg.43
Products for natural thermal insulation:		
cork	• CorkPanels density 160 kg/m ³ - compressed blond cork panels	pg.44
	• CorkPanels L density 180 kg/m ³ - compressed blond cork panels	pg.46
wood fiber	• FiberTherm ® protect densities 230 - 265 kg/m ³ - wood fiber panels for external and internal use	pg.48
	• FiberTherm ® protect dry densities 110 - 140 - 180 kg/m ³ - wood fiber panels for external and internal use	pg.50
	• FiberTherm ® internal density 160 kg/m ³ - wood fiber panels for internal use	pg.53
	• FiberTherm ® universal density 270 kg/m ³ - high compression resistance wood fiber panels	pg.55
	• Notes	pg.57



Introduction to reinforced insulation system Betontherm

Our **BetonWood® s.r.l.** company, from decades, has developed the special **Betontherm** armored thermal-acoustic insulation system which consists of a series of coupled modular panels for the creation of both internal and external coats (but also ceilings and external cladding in general), with high phase shift thermal, mechanical and compressive strength, density, and in fire resistance class A2.

All these features make the **Betontherm** system excellent for the insulation and protection of walls in public places frequented and exposed to repeated impacts such as hospitals, schools, libraries, prisons and even escape routes in fire prevention systems.

Betontherm panels are made by coupling two different types of panels:

- The **BetonWood®** cement bonded particle board construction panel combines the advantageous properties of rigidity and resistance of cement with the insulating properties of wood fibers and the workability of wood. It is made of high-density Portland type cement and debarked pine wood fibers;
- The highly insulating panels chosen from our natural **Fibertherm®** wood fibers of different densities and thickness, our compressed and super-compressed blond cork **CorkPanels**, and expanded or extruded polystyrene with different compression strengths (based on customer needs).

Betontherm armored thermal insulation panels can be plastered directly. Their surface, using a specific mortar for the type of material, is also suitable for ceramic and stone coverings.

Alternatively they can also be finished with plasterboard.

For more information contact our **technical department** at info@betonwood.com.

It is guaranteed by constant checks carried out by external bodies which certify its high quality and, thanks to its high percentage of recycled material (see the single Environmental Product Declarations) it fully complies with the **Minimum Environmental Criteria** and is **CAM** certified.

The fire resistance class and suitability for escape routes is guaranteed by the European standard 2003/43/EC - standard EN 13501-2. The external panel of **Betontherm** system, made with **BetonWood®** cement bonded particle boards, is therefore fire certified with the new European CE classes in class A2fl-s1, moreover the European standardization EN 13501-2 has also been implemented by the Italian state with the D.L. 16 Feb 2007.

Main properties of **Betontherm** panels:

- fireproof (A2-fl-s1 class according to DIN 13501-2)
- CE certified
- resistant to atmospheric agents
- waterproof
- resistant to fungi, molds, insects
- unassailable by animals, rodents, termites, etc.
- free from formadeide and asbestos
- free from recycled inks
- anti-freeze
- workable with woodworking tools
- high density
- high mechanical resistance
- resistant to vandalism
- harmless to humans and the environment



Application areas

The **Betontherm** system is usually used as armored external insulation for internal walls, partitions and external perimeter walls, but thanks to its installation methods and its structure it can also be installed on other elements such as ceilings, attics.

Betontherm panels have multiple uses, in particular they can be used in:

- wood / metal and prefabricated buildings
- thermal and acoustic insulation / insulation
- external and internal thermal coats
- ventilated roofs
- dividing walls
- high resistance counter-walls
- fireproof walls and fire doors
- systems with high thermal displacement
- high-capacity mezzanines and attics
- false ceilings
- fireproof coatings
- road and railway noise barriers
- internal coatings with high mechanical resistance
- vandal-proof protective coatings etc.

To inquire about the application of the **Betontherm** panel in other sectors not listed therein, please contact our technical department at info@betonwood.com.

Thanks to its characteristics of high thermal displacement together with the high mechanical strength and fire resistance in class A2, the **Betontherm** system is suitable for numerous areas of use:

- public and private buildings
- commercial buildings
- education buildings
- public health buildings
- trade fair events
- prefabricated
- public and private furnishings
- entertainment centers
- wooden houses
- country houses
- stores
- condominiums
- prisons
- anti-seismic buildings

The application of the panels and the construction structure vary according to the individual design. It is necessary to take into account the physical, mechanical and thermodynamic characteristics of the **Betontherm** panels and the principles of building construction.



Thermal insulating system Betontherm®

The reinforced insulation Betontherm is a complete system for the external/internal thermal coating, ideal for new buildings and renovations.

The thermal insulation system allows the structure to be continuously insulated from both heat and cold and to minimize the risk of condensation, exploiting the thermal storage capacity of the wall and minimizing thermal changes.

Betontherm is a panel made of **BetonWood®** cement bonded particle board on the outside and in highly insulating material on the inside.

The various types can be viewed on the next page.

The panels have been designed to withstand shocks and bad weather, even the most severe such as hail and heavy rain, thermal expansion, structural settlements and earthquakes.

The interlocking batting guarantees perfect sealing and protection against thermal infiltration and humidity, isolating both cold and heat, eliminating the risk of cracking and cracks due to thermal expansion.

The installation is easy, clean, fast and does not require expert manpower; the panels are fixed by applying the adhesive on the back and 5 anchors to be fixed in correspondence with the special milling on the external surface; being a pre-finished and ready-to-use cladding, it does not require fixed scaffolding, as installation requires a single and rapid step.



Figure 1 Betontherm fiber panel made with **BetonWood®** cement bonded particle board and **Fibertherm®** wood fiber

Betontherm fiber

betonwood + wood fiber panel



Betontherm®fiber is the armored thermal insulation system made with a high density cement bonded particle board 1350kg/m³ (compressive strength ≥ 9000kPa) and one in insulating wood fiber **Fibertherm®** density 160kg/m³.

Betontherm fiber dry

betonwood + wood fiber panel



Betontherm®fiber dry is the armored thermal insulation system made with a high density cement bonded particle board 1350kg/m³ (compressive strength ≥ 9000kPa) and one in insulating wood fiber **Fibertherm®dry** density 110kg/m³.

Betontherm fiber base

betonwood + wood fiber panel



Betontherm®fiber base is the armored thermal insulation system made with a high density cement bonded particle board 1350kg/m³ (compressive strength ≥ 9000kPa) and one in insulating wood fiber **Fibertherm®base** density 250kg/m³.

Betontherm cork

betonwood + blond cork panel

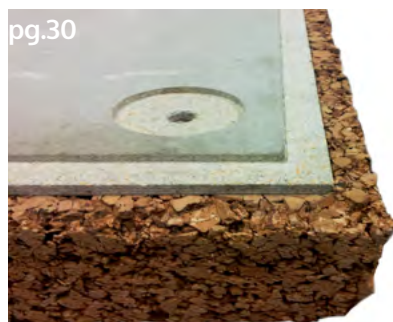

Betontherm®cork is the armored thermal insulation system made with a high density cement bonded particle board 1350kg/m³ (compressive strength ≥ 9000kPa) and one in insulating blond cork **CorkPanels** with density 160kg/m³.

Betontherm styr EPS

betonwood + expanded polystyrene



Betontherm®styr EPS is the armored thermal insulation system made with a high density cement bonded particle board 1350kg/m³ (compressive strength ≥ 9000kPa) and one in insulating expanded polystyrene **EPS** density 14+16 kg/m³ and compressive strength 70kPa.

Betontherm styr XPS

betonwood + extruded polystyrene 300kPa



Betontherm®styr XPS is the armored thermal insulation system made with a high density cement bonded particle board 1350kg/m³ (compressive strength ≥ 9000kPa) and one in insulating extruded polystyrene **XPS** density 30kg/m³ and compressive strength 300kPa.



Betontherm strong

betonwood + extruded polystyrene 700kPa

Betontherm®strong is the armored thermal insulation system made with a high density cement bonded particle board 1350kg/m³ (compressive strength ≥ 9000kPa) and one in insulating extruded polystyrene **XPS strong 700** density 40kg/m³ and compressive strength 700kPa.



Natural insulations **Fibertherm®** & **CorkPanels**

Our completely natural thermal insulations offer excellent thermal displacement and, in the case of blond cork, protection from moisture and mold.

The thermal insulation system allows continuous insulation in correspondence with structural elements with consequent correction of thermal bridges. In this way, the voltages deriving from temperature variations that would occur without this type of protection are reduced.

The thermal insulation systems in **FiberTherm®** protect wood fiber and **CorkPanels** blond cork can be plastered directly and guarantee high performance and durability; all characteristics that make them reference systems in many European countries.

The high dimensional stability of our natural products for thermal insulation, depending on the thermo-hygrometric conditions, helps to eliminate the expansion and cracking that can reduce the duration of the external coating.

Fewer dilations and cracks mean an increase in the duration of the coat.

Our thermal insulation systems can be used both on wood-like walls, on traditional masonry and on solid mineral bases.

For different needs and processing methods, BetonWood srl supplies panels in small and large sizes, with smooth edges with sharp edges or with tongue & groove edges.



Figure 2 Example of a solution for a natural internal thermal insulation system made of **Fibertherm® protect** wood fiber

Corkpanels

compressed blond cork panels

pg.44



CorkPanels is the completely natural thermal coat made of compressed blond insulating cork with medium density $150\pm 160 \text{ kg/m}^3$.

Corkpanels L

compressed blond cork panel

pg.46



CorkPanels L is the completely natural thermal coat made of compressed blond insulating cork with medium density $150\pm 180 \text{ kg/m}^3$.

Fibertherm protect

wood fiber densities 230 - 265kg/m³

pg.48



Fibertherm® protect is the completely natural thermal insulation system made with insulating wood fiber with a density of your choice between 230 and 265 kg/m^3 . The panel can be plastered directly, and is suitable for installation both indoors and outdoors.

Fibertherm protect dry

wood fiber densities 110 - 140 - 180 kg/m³

pg.50



Fibertherm® protect dry is the completely natural thermal insulation system made with insulating wood fiber with a density of your choice between 110,140 and 180 kg/m^3 . The panel can be plastered directly, and is suitable for installation both indoors and outdoors.

Fibertherm internal

wood fiber density 160kg/m³

pg.53



Fibertherm® internal is the completely natural thermal insulation system made with insulating wood fiber with a density of 160 kg/m^3 . The panel can be plastered directly, and is suitable for indoor installation.

Fibertherm universal

wood fiber density 270kg/m³

pg.55



Fibertherm® internal is the completely natural thermal insulation system made with insulating wood fiber with an high density of 270 kg/m^3 . The panel can be plastered directly, and is suitable for indoor installation.



CAM certified cement bonded particle board

to obtain the SUPERBONUS 110%

“The Relaunch Decree n. 34 of 19 May 2020, as part of the works for the energy redevelopment of existing buildings (superbonus 110%), introduced environmental sustainability requirements on insulating materials (for external thermal insulation of the opaque building envelope: walls, attics, roofs). These requirements are indicated in the CAM Minimum Environmental Criteria, introduced for public tenders in the building sector with the Ministerial Decree of 11 October 2017.



The goal of thermal insulation is to reduce the consumption of energy resources necessary for heating and cooling buildings, reducing atmospheric pollution due to the emission of polluting gases resulting from the combustion processes of energy sources of fossil origin.

Aware that construction is responsible for 40% of total greenhouse gas emissions into the atmosphere, energy efficiency is the European priority in the fight against climate change. Therefore, even the materials necessary for energy saving must be considered for their environmental impact, energy consumption and social costs, in their entire life cycle.

The importance of the EPD

Environmental Product Declaration

The designer must make technical design choices that make it possible to meet the criterion and must prescribe that in the procurement phase the contractor must ensure compliance with the criterion. The percentage of recycled material must be demonstrated through one of the following options:

- an Environmental Product Declaration of Type III, compliant with the UNI EN 15804 standard and the ISO 14025 standard, such as EPDItaly® or equivalent;
- a product certification issued by a conformity assessment body certifying the recycled content through the clarification of the mass balance, such as ReMade in Italy®, Plastic Second Life or equivalent;
- a product certification issued by a conformity assessment body that certifies the recycled content through the clarification of the mass balance which consists in the verification of a self-declared environmental declaration, compliant with ISO 14021.





Attention to the Environment

At **BetonWood**, we are proud of the environmental role we play in the overall cement bonded particle supply chain.

By producing wood-based panels using waste wood from the sawmill industry, we help ensure that timber is valued as a limited raw material. We aim to get the maximum possible yield from our products. The result is economic production with the lowest possible environmental impact.

Together with our suppliers, we are committed to achieving the lowest possible environmental impact.

- We make sure that as little waste as possible enters the water, soil and air.
- We promote the recycling of the largest possible amount of waste materials and accelerate the recycling of wood waste.
- We manage, use, store and destroy chemicals with healthy and environmentally safe means.

BetonWood guarantees that our products are not made with wood from national parks, nature reserves, virgin forests and other protected areas; a wood certified "Forest Stewardship Council"® (FSC®), PEFC™, with CE mark.

The certifications of our **BetonWood**® cement bonded particle board are shown on the following pages.

FSC® certification

"Forest Stewardship Council"®

The "Forest Stewardship Council"® (FSC®) is an international NGO that has created an internationally recognized forest certification system. The certification has as its purpose the correct forest management and the traceability of derived products.

The "Forest Stewardship Council"® (FSC®) mark indicates that the wood used to manufacture a certified product comes from a forest that is properly managed according to rigorous environmental, social and economic standards. The forest of origin has been independently controlled and assessed in accordance with the principles and criteria for forest management established and approved by the "Forest Stewardship Council"®.

The FSC® trademarks can be used both on products composed of forest-based material and on promotional material. Only certified companies can use FSC® labels on their products. Any company wishing to use FSC® labels on the products it manufactures must therefore first have obtained Chain of Custody (CoC) certification.





PEFC™ certification

“Programme for Endorsement of Forest Certification”™

The PEFC™ is an association that constitutes the national governing body of the PEFC™ certification system (Program for Endorsement of Forest Certification schemes), ie the Evaluation Program of forest certification schemes.

The PEFC™ is an international initiative based on a broad understanding of the parties involved in the implementation of sustainable forest management at national and regional level. Representatives of forest owners and poplar groves, end consumers, users, freelancers, the world of the wood industry and crafts participate in the development of PEFC™. Its objectives include improving the image of silviculture and the forest-wood supply chain, effectively providing a market tool that allows the marketing of wood and forest products deriving from forests and plants managed in a sustainable way.

PEFC™ is your guarantee that the woody raw material for paper and wood products comes from sustainably managed forests. Certified forests are checked by independent inspectors.



CARB certification

“California Air Resources Board”

The California Air Resources Board (CARB) imposes some of the most stringent controls in the world regarding air quality and the reduction of pollutants. The agency’s management extends from the automotive industry to the manufacturing of consumer products and, by rewarding sustainable producers and placing strong constraints on those who do not meet CARB standards, set the global precedent for ecological production.



BetonWood srl constantly works to provide products with the best production processes, the best raw materials, raw materials and products with minimized emissions. The recognition of the CARB certification for the production of cement bonded particle boards is the confirmation that the research carried out by **BetonWood®** has paid off.

As a result, **BetonWood srl** is proud to confirm that all **BetonWood®** cement bonded particle products comply with the very low emission E-LE CARB II standard. Since 2015 we have been delivering cement bonded particle boards only in E-LE quality.



ISO14001 certification

“Environmental Management System”



The ISO 14001 standard establishes the generic requirements of an environmental management system. Regardless of the type and size of the organization, the requirements of an environmental management system do not change. It is in this sense that the ISO 14001 standard offers a comprehensive approach to the strategic environmental choices of a company. What ISO 14001 requires is the commitment to comply with the mandatory requirements of current legislation, together with the commitment to continuous improvement.

An environmental management system that complies with the requirements of ISO 14001 is a management tool that allows the organization to identify and control its environmental impacts, to continuously improve environmental performance and to implement a systemic approach in defining important objectives and targets. environmental.

By obtaining this certification, **BetonWood srl** is committed to working in compliance with all environmental regulations and instructions.

Fire resistance certification

LAPI is a private laboratory that has been operating since 1983 in the sector of industrial analysis and testing. Specialized in fire behavior tests (where he occupies a position of absolute importance at a European level) LAPI has for some time undertaken analysis in other sectors, while maintaining its identity as a fire testing laboratory.

LAPI operates as a certification and inspection body with the authorization of the Ministries and on the basis of the notification for the Directives indicated. The checks are carried out in accordance with the procedures of EN ISO IEC 17020-EN 45011.

In 2015 LAPI SpA obtained accreditation as a Certification Body for Products, Processes and Services according to the UNI EN ISO IEC 17065: 2012 standard by ACCREDIA (No. PRD 241B). This accreditation provides the guarantee that the LAPI Quality System guarantees compliance with the requirements of competence, consistency and impartiality of the certification bodies of products, processes and services.

We are proud to declare that our BetonWood cement bonded particle products have obtained fire resistance certification in class A2fl-s1.



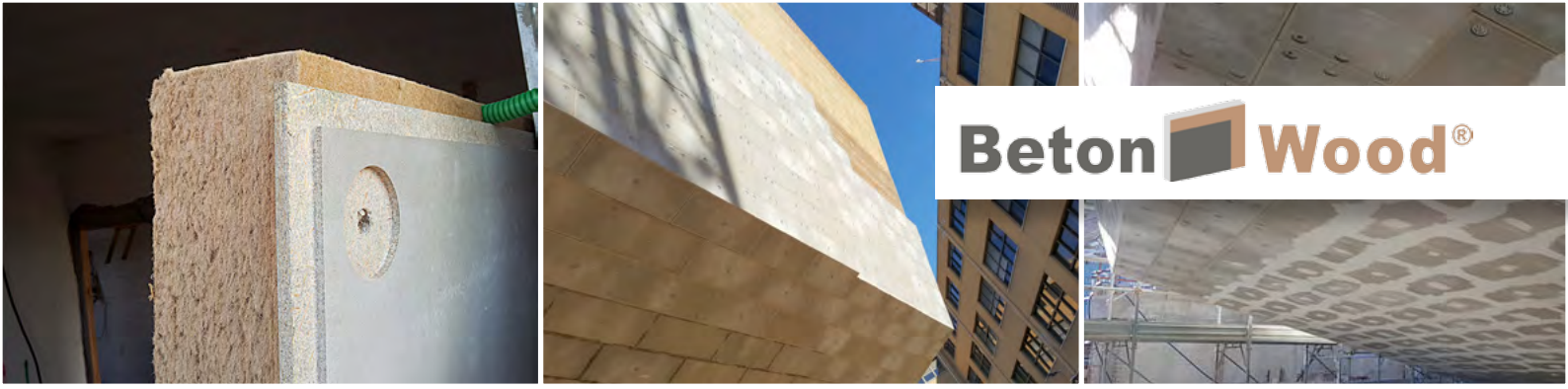

Cement bonded particle board's characteristics

Density

In accordance with the requirements of EN634-2, article 2, the density of the panels must be greater than 1000 kg/m³. According to the results obtained from tests at a temperature of 20°C, an ambient relative humidity of 50 - 60% and a residual humidity present in the panel equal to 9%, the **BetonWood®** density is $\delta = 1350 \pm 75 \text{ kg/m}^3$
 For static calculations - for safety reasons - it is recommended to increase or decrease the maximum value of 20%.

Moisture content in transport

Similarly to wood in natural conditions, **BetonWood®** panels absorb a balanced moisture content depending on the temperature and atmospheric humidity. The moisture content in accordance with the specifications dictated by the MSZ EN634-2 standard is $\mu = 9 \pm 3\%$ achievable in balanced hygroscopic conditions at a temperature of 20°C and a relative humidity of 50 - 60%.

Moisture content depending on the humidity in the air

Figure 1 Average balance of the moisture content of cement bonded particle boards as a function of air humidity, t=20°C

at a temperature of 20°C and a relat. humidity of 35%, the moisture content is about 7%;
 at a temperature of 20°C and a relat. humidity of 60%, the moisture content is about 12%;
 at a temperature of 20°C and a relat. humidity of 90%, the moisture content is about 19%;

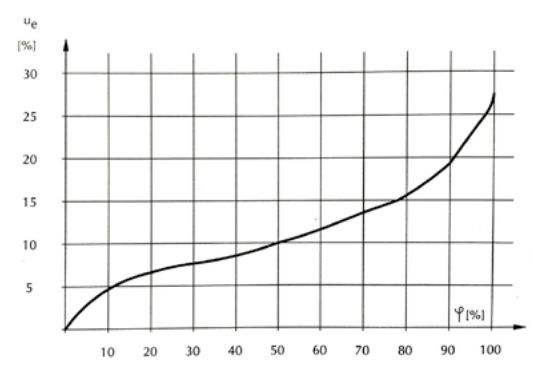

Absorption of water and steam

It is known that humidity plays a significant role in the deterioration process of the wooden materials contained in the panel. Therefore it is very important to determine the rules of water absorption and transmission as accurately as possible.

Absorption of water vapor in the atmosphere with high humidity and high temperatures (tropical climate):

t=40°C
 φ=100%

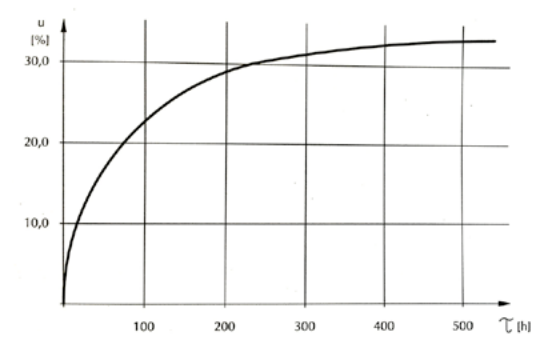

Figure 2 Water vapor absorption of **BetonWood®** in dry condition

The state of temporary absorption of the cement bonded particle boards shows a deviation. This deviation is due to the heterogeneous and partially organic composition of the panel as well as the difference in density. Within the individual samples, the elements with the highest and lowest density show, respectively, levels of lower and higher absorption and lower and higher values of humidity that the panel is able to absorb have been obtained.



Absorption of water vapor in atmospheric spaces:

$t=20 \pm 2^{\circ}\text{C}$
 $\phi=45 \pm 5\%$

Figure 3 Absorption of the **BetonWood®** panel saturated by exposure to rain, and subsequently dried in atmospheric space

Figures 3 and 4 show the average temporary moisture content in cement bonded particle boards wet to saturation by exposure to rain and steam and subsequently dried to a state of absolute dryness, as a function of time. It can be seen that the maximum water absorption of the pre-treated panel has changed. The balance of moisture content given by the atmosphere should be approximately 7%. The figures show us that not even the pretreated panels reach this value although the available absorption time seems to be sufficient.

Figure 4 Absorption of the vapor-saturated **BetonWood®**, and subsequently dried in atmospheric space ($t=20 \pm 2^{\circ}\text{C}$; $\phi=45 \pm 5\%$)

Water absorption in the rain

Water absorption with temperature $14 \pm 0,5^{\circ}\text{C}$ and water pressure equal to 2 bar:

$t=14 \pm 0,5^{\circ}\text{C}$
 $p=2 \text{ bars}$

Figure 5 Absorption of the **BetonWood®** panel saturated by exposure to rain ($t=14 \pm 0,5^{\circ}\text{C}$; $p=2 \text{ bars}$)

Desorption of BetonWood® panels

Desorption in atmospheric spaces

$t=20 \pm 2^{\circ}\text{C}$
 $\phi=50 \pm 5\%$

Figure 6 Desorption of **BetonWood®** panels saturated with water vapor absorbed in the atmospheric environment ($t=20 \pm 2^{\circ}\text{C}$; $\phi=50 \pm 5\%$)

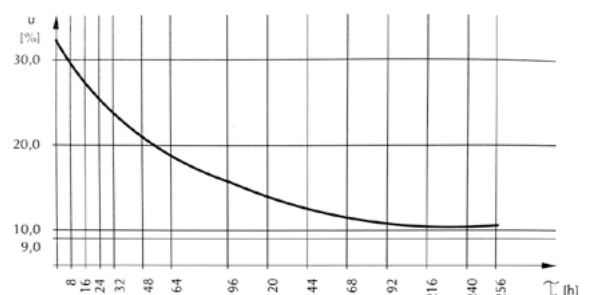
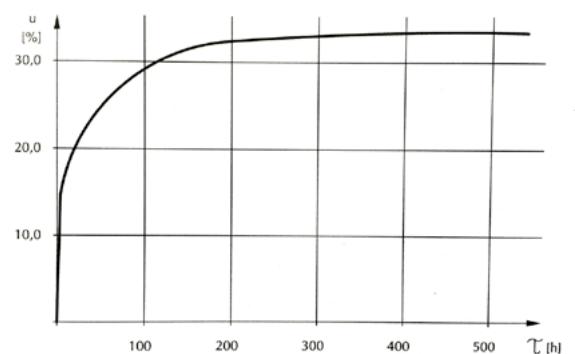
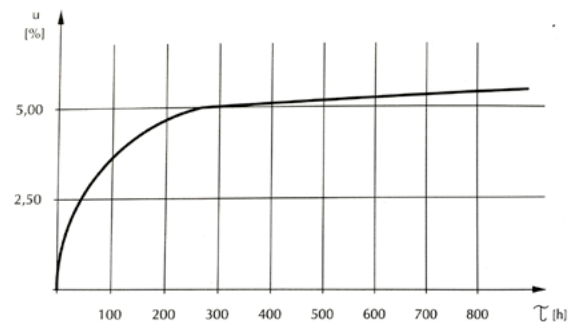
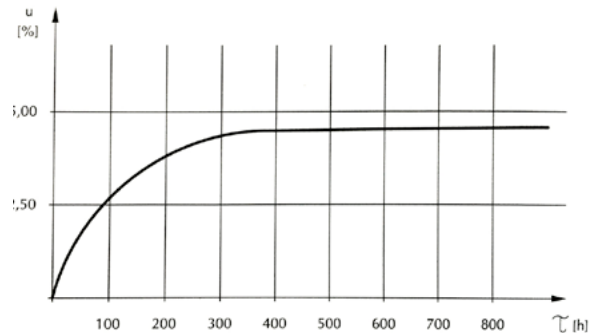



Figura 7

Desorption of **BetonWood®** panels saturated with water vapor absorbed in an atmospheric environment ($t=20\pm 2^\circ\text{C}$; $\varphi=50\pm 5\%$)

Figures 6 and 7 show the average temporary moisture content in cement bonded particle boards wet up to saturation by the absorption of water vapor and exposure to rain, respectively, as a function of time.

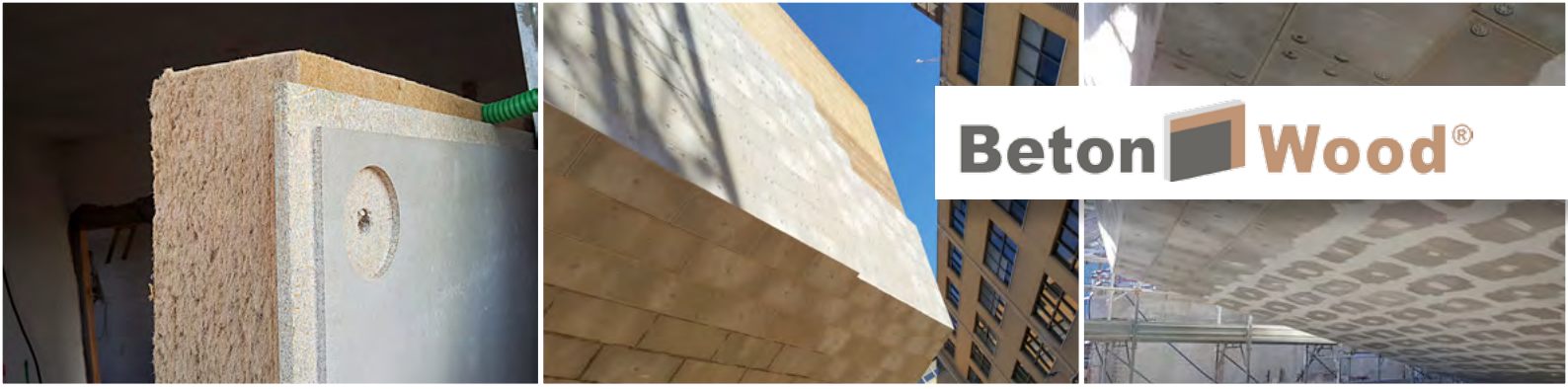
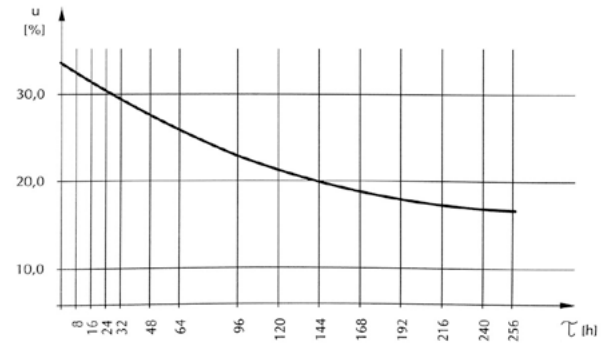

Desorption of the panel in a balanced state in atmospheric spaces up to a state of absolute dryness:

$t=102^\circ\text{C}$
 $\varphi=0\%$

Figure 8

Desorption of **BetonWood®** panels saturated by the absorption of water vapor in the atmospheric environment to a state of absolute dryness

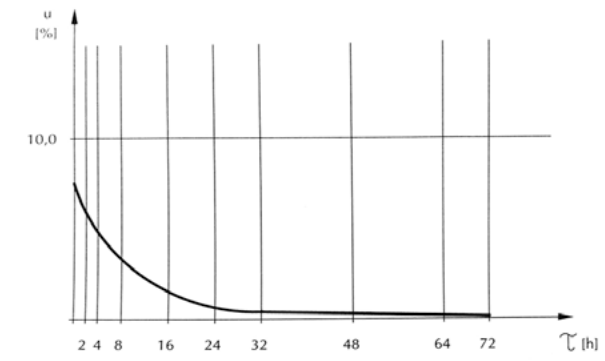
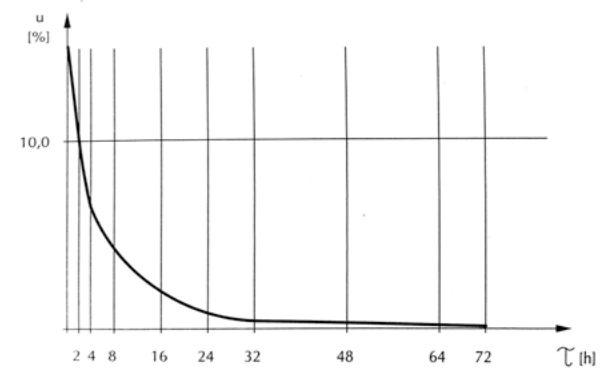

Figure 9

Desorption of **BetonWood®** panels saturated by exposure in the rain in an atmospheric environment to a state of absolute dryness

Figures 8 and 9 show the average temporary moisture content in cement bonded particle boards wet to saturation through the absorption of water vapor and exposure to rain, respectively, as a function of time.



Conclusion

It can be said that the maximum water absorption of cement bonded particle boards is not greater than 35% even for conditions of permanent humidity or immersion. It is independent of the method of increasing humidity used. The waterproofing pre-treatment of the panels significantly affects the absorption characteristics.



Water absorption of the panels by soaking

Figure 10 shows the average temporary moisture content of the perfectly dry **BetonWood**® panel as a function of time. The resulting curve runs logarithmically, precisely indicating the diffusion rules.

It can be said that initially the absorption of water increases drastically and reaches a μ_{max} value after about 50 hours of soaking. There was no significant change in moisture content after this soak time.

La media del valore μ_{max} è 27%.

Figure 10

Water absorption of the **BetonWood**® panel by soaking.

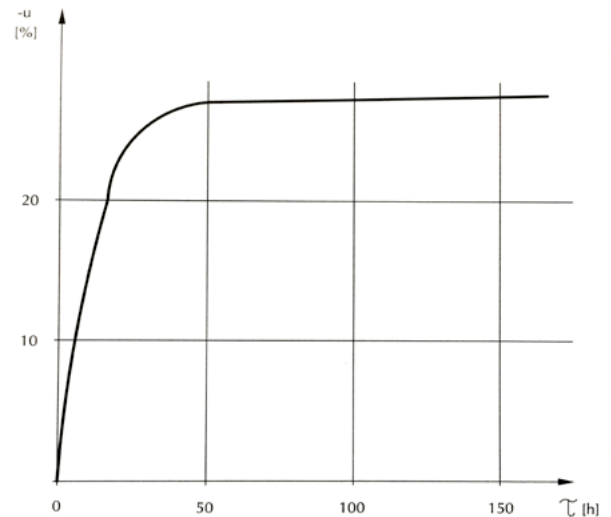

Resistance to deformation

The two layers of the cement bonded particle boards are generally subjected to an asymmetrical climatic load. A test was carried out under the following extreme conditions: the upper part of the specimen placed freely in a water bath was brought into contact with the air at a temperature $t=20 \pm 2^\circ\text{C}$ and a relative humidity $\phi=65 \pm 5\%$. Figure 11 shows the arrangement of the measuring points as a result of deformation, as a function of time.

Figure 11

The measurement points arranged due to the asymmetrical climatic load reported as a function of time

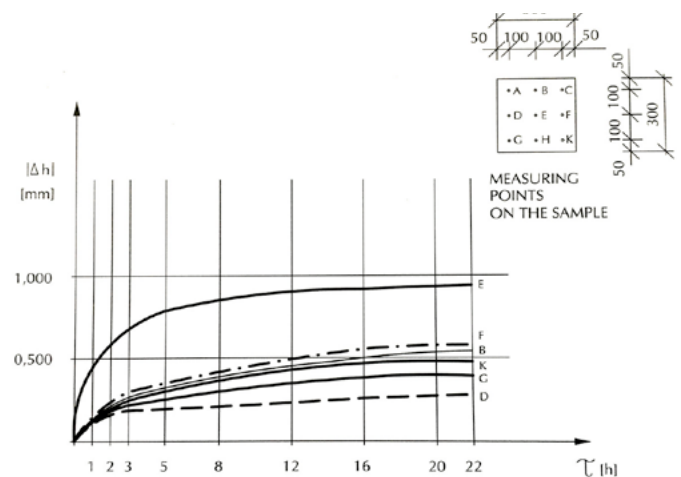
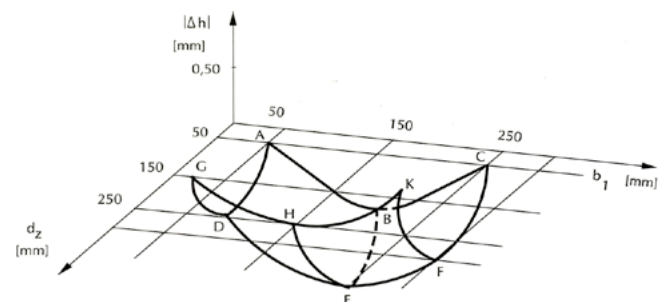
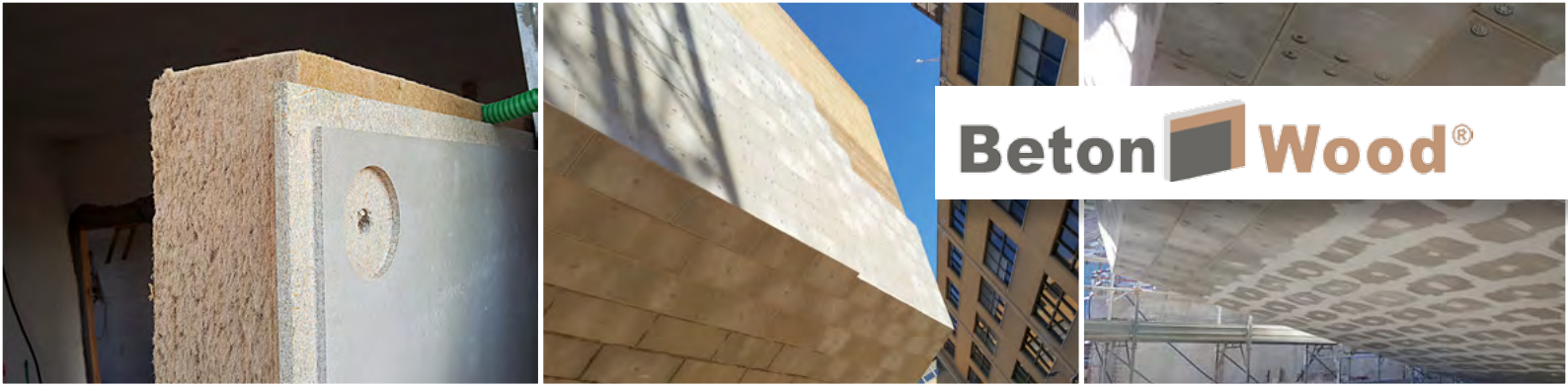

Figure 12

Axonometric drawing of the highest deformation

The most drastic deformation can be observed in the first 3 days. The highest deformation can be noticed on the 22nd day. In subsequent observations the deformation is insignificant.





Thermodynamic characteristics of cement bonded particle board

Parameters	Unit	Values
Density	kg/m ³	1350 ± 100
Fire reaction class according to EN 13501-1	-	A2-fl-s1
Thermal conductivity coefficient (λ)	W/(m•K)	0,26
Specific heat (c)	J/(kg•K)	1880
Coefficient of linear thermal expansion (α)	K ⁻¹	1,0 × 10 ⁻⁵
Steam penetration coefficient (Δ)	kg/m s Pa	0,83 × 10 ⁻¹¹
Coefficient of resistance to vapor diffusion (μ)	-	22,6
Steam penetration coefficient (D)	-	0,0039
Air permeability	l/min. m ² Mpa	0,133

Table 1 Shows the construction characteristics of the cement bonded particle boards

Thickness mm	Thermal resistance m ² K/W
22	0,1008

Table 3 Thermal resistance values of 22mm thick panels

Thickness mm	Transmission heat W/m ² K
22	3,078

Table 4 Heat transmission values of 22mm thick panels

Thickness mm	Soundproofing power dB					
	100	200	400	800	1600	3150
	Frequency Hz					
22	19,0	23,1	29,3	34,8	40,2	45,9

Table 5 Shows the acoustic performance of 22mm thick panels

Fire resistance class

BetonWood® panels fall into the fire resistance category **A2-fl-s1**. Below are the previews of the LAPI certification which can be freely consulted on our website at:

<http://www.betonwood.com/pdf/certificazione-al-fuoco-A2fl-s1.pdf>





General strenght properties of BetonWood® panels

To limit stress, the specifications given by the MSZ 15025/1989 regulations should be adopted as a design guide. When designing building structures, the following permissible stresses must be taken into account based on the data provided by the "Institut für Bautechnik" in Berlin.

- bending strength for loads perpendicular to the panel surface: **1,8 N/mm²**
- permissible tensile strength flat on the panel: **0,8 N/mm²**
- compressive strength allowed in plane to the panel: **2,5 N/mm²**
- modulus of elasticity in bending for calculation purposes: **2000 N/mm²**

There is approximately a linear correlation between the flexural strength and the modulus of elasticity for **Betontherm**. panels.

Figure13

Correlation of the flexural strength with the curve of the panel's elasticity modulus

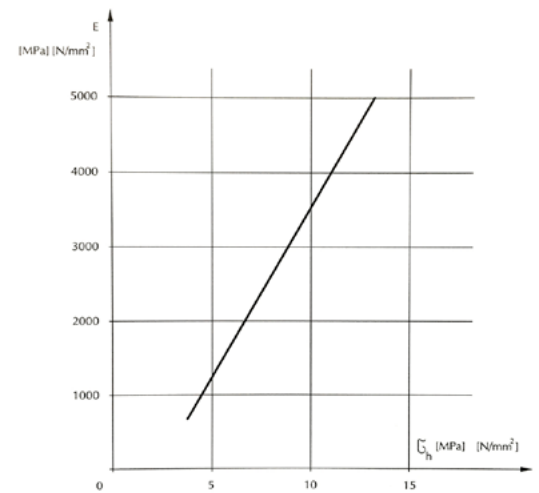

Resistance to deformation

Specimens with uniform cross section but different length were used for testing. Figure 14 shows a varied range of section reductions and the corresponding critical resistance values.

Figure 14

Critical resistance value as a function of the panel thickness reduction

In **BetonWood**® panels, deformation occurs on large-format panels and not on small-format ones. The deformation resistance can be determined by a simple accurate calculation.

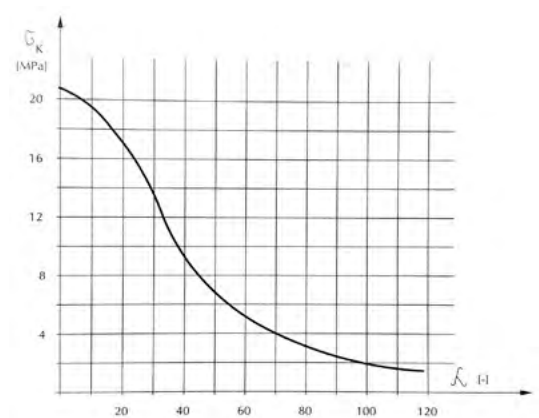

Behavior of panels under the influence of a thermal load

The thermodynamic curve can be obtained by plotting the deformation as a function of temperature.

Figure 15

Thermodynamic curves of the **BetonWood**® panels

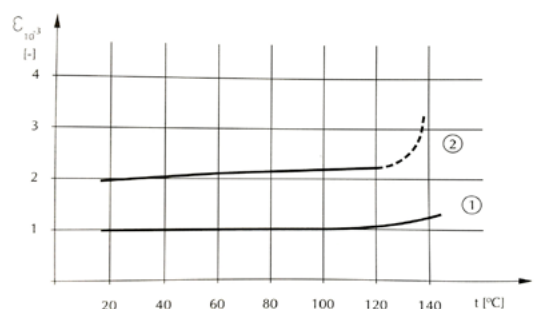



Beton Wood®

1. Curve corresponding to 35% of the flexural strength, and to the nominal stress $\delta_1 = 3,79$ MPa
2. Curve corresponding to 70% of the flexural strength, and to the nominal stress $\delta_1 = 7,59$ MPa

The test indicates that:

- the thermodynamic curve can be considered linear above a temperature of 120°C;
- the straight section corresponding to the highest nominal stress is steeper thanks to the effect of the temperature increase on the non-linear part of the diagram;
- for higher nominal stress, from a temperature of 100°C, an increasing number of samples did not pass the load tests, at a temperature of 140°C all the samples failed under load.
- **the highest thermal load limit for BetonWood® panels is 120°C**

Effect of moisture content on resistance values

The different resistance values of the cement bonded particle boards are interconnected with the humidity content prevailing at a given time.

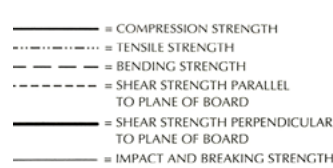
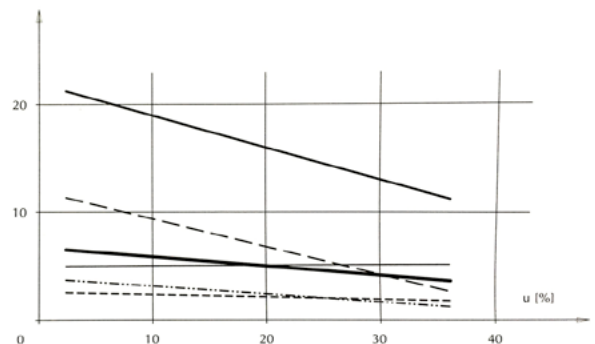

Figure 16

Resistance change as a function of moisture content



It can be said that the compressive strength and flexural strength decrease considerably thanks to the increase in the moisture content. The tensile, shear and break resistance changes slightly under the influence of the moisture content. The impact resistance to breakage, unlike the other properties, slightly improves thanks to the increase in the moisture content.

Viscous flow in BetonWood® panels due to bending stress

For the design of load-bearing structures intended to last the change of individual properties over time plays a significant role. It should be taken into consideration, when designing building structures, that the macromolecular composition of the wood changes some mechanical properties while the physical properties remain unaltered.

Figure 17

Change of deformation in BetonWood® panels as a function of load coefficient and time

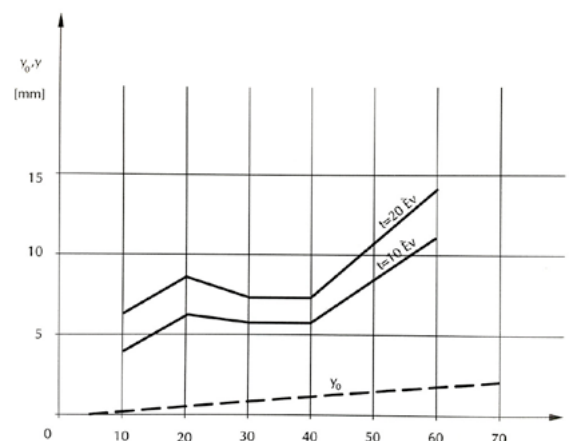



Tests have shown that initial elastic deformations are much more favorable for cement bonded particle boards than traditional building boards. This happens thanks to the very high flexural rigidity. The initial elastic deformation of **BetonWood®** building panels is only 1/5 of the value obtained for the panels used in furniture.

The degree of creep can be clearly characterized by the multiplication factor α , which depends on the loading time and when multiplied by the references y_0 the actual deformation corresponds to the loading time t . Although the α values for cement bonded particle boards are usually 2-4 times greater than those obtained for standard panels, if the loading time exceeds 1 year, the actual deformations will be significantly lower.

The viscous flow of cement bonded particle boards consists of 3 main phases:

phase 1: in this initial phase the deformation occurs at the highest rate and lasts for 3-5 days / on average 100 hours.

phase 2: the rate of deformation becomes constant, the deformations show a linear increase as a function of time and last for 5-30 years

phase 3: creep will stop or slow down to a negligible degree

Fungi and insect resistance

Tests on cement bonded particle boards performed for resistance to fungi have been performed for decades by the Department of Forest Protection Methods at the University for Forestry and Wood Industry.

Tests were carried out on the panels for their resistance to mold in accordance with the MSZ 8888/9-69 standard.

Tests have proved that **BetonWood®** panels are "fungicides".

Tests for resistance to fungi of rotten wood were also conducted in accordance with the MÉMSZ 50 373 standard. In the tests, cultures of *Coniphora cerebella*, *Poria vaporaria* and *Trametes versicolor*, which are the most harmful fungi in the field of building structures, were used: none of the species of fungi have damaged the **BetonWood®** panels, therefore, it has been proven that the cement bonded particle boards are "resistant to fungi". This is confirmed by the results of tests performed by Mutsui Lumber Company, Tokyo.

It has been proven by tests carried out by European institutes that termites do not attack the **BetonWood®** cement bonded particle boards even in the phase of acute hunger. \BAM, Bundesanstalt für Materialprüfung, Berlin, test result No. 5.1;\4403,1985\.

The insect resistance of **BetonWood®** panels has also been confirmed by the University of Tokyo, Faculty of Agriculture.

Weather resistance

BetonWood® panels are resistant to atmospheric agents, as the wood fibers are protected by the cement against external damage.

The series of tests conducted by the WoodWorking Research Institute confirms these results. The cement bonded particle boards have been tested by EMPA/Switzerland, 1975/ in a series of measurements consisting of 150 cycles at a temperature of -20°C and +20°C and at a variable humidity level. These tests definitively qualify the panel as frost resistant.

It follows that the **BetonWood®** panels without finishing are able to withstand atmospheric agents and extreme stresses.

In the permanent change of relative humidity, effect of direct rain, water and steam cause a change in the moisture content of the panel (see paragraphs on moisture content).

The change in moisture content causes a limited dimensional change.

Dimensional change in plane: at a temperature of +20°C, with a range of relative humidity from 25% to 90%: maximum 0.3%.

In practice: for $\pm 10\%$ variation in the moisture content of the panel: $\pm 2\text{mm/m}$.

When offering structure, these dimensional variations should be taken into account.

The Quality Control Institute for the Construction Industry obtained the following results:

Thickness bulge	0,92%
Dimensional variations in plan	0,15



Processing and fixing of BetonWood® panels

Main principles of processing

The processing of **BetonWood**® requires the use of tools with a carbide tip. Traditional hand tools (iron, chrome-vanadium) can also be used although, in this case, wear will be greater. Manual processing is facilitated by the use of metal saws or metal boring machines (recommended to improve dust extraction while working the panels).

The minimum suction speed should be 30m/s.

Cut on measure

The use of carbide tipped saws is recommended. The cutting depth should be adjusted so that the saw blade protrudes slightly (3-8 mm) from the **BetonWood**® panel.

An excellent quality of the edges, an increase in the durability of the same and a low cut resistance can be obtained using a saw with carbide serrated blades as shown in figure 21. Blades with other shapes can also be used taking into account that the durability of the border will be reduced.

($n_{\min} = 4500 \text{ min}^{-1} = 75 \text{ s}^{-1}$)

Grooves cutting

The use of carbide tipped saws is recommended. ($v = 1.5 - 6 \text{ mm}$).

($n_{\min} = 5300 \text{ min}^{-1} = 88 \text{ s}^{-1}$)

Circular cut and other cut's types

An electric compass can be used to cut holes with a diameter larger than 30 mm as well as for cutting other shapes and for cutting corners.

($n_{\min} = 1600 \text{ turns/min}$)

Drilling

High speed steel boring machines with standard carbide tipped tools are recommended for this operation.

($n_{\min} = 400 \text{ W}$; $n_{\min} = 1200 \text{ min}^{-1} = 20 \text{ s}^{-1}$)

Boring machines with maximum revolutions per minute can create cleaner holes. It is recommended to use a piece of solid wood at the exit point of the boring machine. The cutting feed rate should be kept to a minimum.

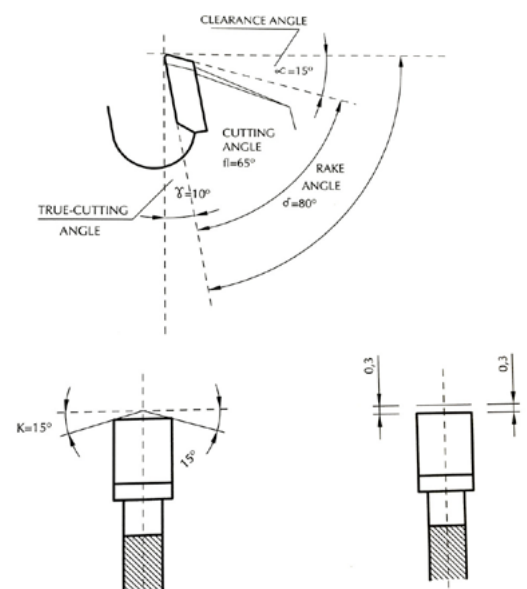

Figure 21

Types of teeth used for cutting **BetonWood**®



Types of recommended tools:

- from 1.5 to 16 mm in diameter: twist drill with a cone angle of 60 °
 - from 8 to 16 mm in diameter: mortiser with guide tip and incision margin
 - from 16 to 40 mm in diameter: boring machine with guide tip and cutting edge
- Boring machines with a diameter from 1.5 to 16 mm can be used with excavation devices having a hard metal tip.

Milling

It is recommended, also for these operations, to use milling machines with carbide tips. Reversible blade set of milling machines ensure quick replacement and high accuracy. ($n_{\min} = 22000 \text{ min}^{-1} = 367 \text{ s}^{-1}$)

Sanding

Edge irregularities can be eliminated by sanding. The recommended dimensions for the sandpaper grit are: 60 - 80. An appropriate depth of cut can be reached with the use of belt sanders. Dust extraction should be ensured in all circumstances. ($v = 350 \text{ m/min}$)

Finishing and painting

For the finishing of **BetonWood**[®], the following recommendations should be considered:

- thanks to its considerable cement content, the panel shows alkaline reactions;
- the surface of the panel is smooth and quite absorbent;
- the moisture content should not exceed 14%.

Due to the alkalinity of the panel, alkali-resistant materials should be used for finishing **BetonWood**[®] panels and an alkali-resistant base coat should be applied.

What is priming for:

- to reduce surface alkalinity
- to make the absorbency uniform
- to reduce the absorption of moisture

So-called alkali-resistant primers can be used for this purpose. Before applying the finishing materials, it is highly recommended to ask our office for technical information.

BetonWood[®] panels are suitable for use in thermal insulation systems. After fixing the panels to the support structure (X-Lam or metal) and filling the joints with Beton Elastic elastic cement mortar, proceed with the laying of the BetonNet Glass 360 fiberglass mesh and smoothing with Beton AR1.

For painting consult the products in the price list or ask our [technical office](#).



Beton Wood®

Betontherm fiber

Reinforced thermo-acoustic insulation system with BetonWood® cement bonded particle boards and Fibertherm® wood fiber

Betontherm fiber is the ideal system for creating thermoacoustic coatings with high mechanical resistance and high thermal displacement, for the insulation, both internal and external, of the perimeter walls and suitable for both traditional constructions and dry wood systems (type X-Lam or Platform frame).

It is made from two panels of different thicknesses coupled: one made in **Beton-Wood®** cement bonded particle board and the other in **Fibertherm®** wood fiber.

A system designed to offer a simple and effective solution for the creation of a thermal-acoustic insulation system in a short time and without the need for specialized labor. The system provides a high thermal lag thanks to the thermo-acoustic insulation properties of this type of wood fiber.

It is guaranteed by constant checks carried out by external bodies which certify its high quality and, thanks to its high percentage of recycled material (**35%** for cement bonded particle boards and **91,3%** for wood fiber) it fully complies with the **Minimum Environmental Criteria** and is **CAM** certified.

densities 1350kg/m³ and 160kg/m³



Advantages

- high compression strength;
- resistant to climate change and frost;
- resistant to the external environment;
- insects and fungi are unable to attack or damage it;
- extremely hard and impact resistant;
- incombustible (A2 according to the Standard DIN 4102);
- free from recycled inks, formaldehyde and asbestos, etc.;
- workable with wooden tools;
- creates a healthy and completely natural internal atmosphere;
- recyclable, ecological, respects the environment;

Uses in construction

- ✓ external and internal walls with high thermal displacement;
- ✓ fire resistant ceilings, suspended ceilings and walls;
- ✓ fireproof walls;
- ✓ self-supporting and sound-absorbing walls;
- ✓ load support for walls;
- ✓ insulation walls for highly frequented public places;
- ✓ exhibition stands and prefabricated boxes;
- ✓ road and railway noise barriers;
- ✓ reinforced insulating composite systems;
- ✓ vandal-proof protective coatings;

Available sizes

panels with rabbeted edge

Thickness mm	Size mm	kg/m ²	kg/panel	kg/pallet	panels/pallet	m ² /pallet
22 + 80	1250 x 500	40,70	24,42	537,24	22	13,20
22 + 100	1250 x 500	42,90	25,74	463,32	18	10,80
22 + 120	1250 x 500	45,10	27,06	378,84	14	8,40
22 + 140	1250 x 500	47,30	28,38	340,56	12	7,20
22 + 160	1250 x 500	49,50	29,70	356,40	12	7,20

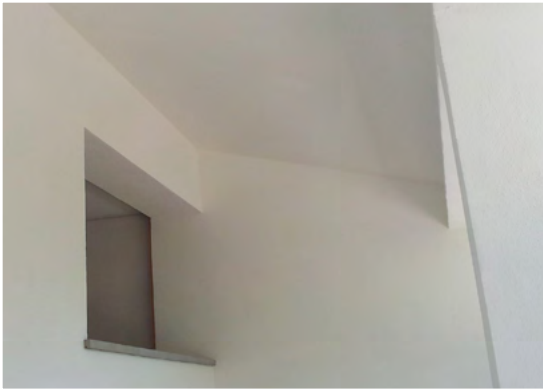

Technical characteristics

BetonWood® cement bonded particle board

Characteristics	Value
Density kg/m ³	1350
Reaction to fire according to the standard EN 13501-1	A2-fl-s1
Coefficient of thermal conductivity λ_D W/(m·K)	0,26
Specific heat J/(kg·K)	1880
Resistance to vapor diffusion μ	22,6
Coefficient of linear thermal expansion α	0,00001
Thick swelling after 24h of permanence in water	1,5%
Change in length and width due to humidity	max 0,3% with temp>20°C and humid. 25% a 90%
Air permeability l/min.m ² MPa	0,133
Surface PH value	11
Flexural strength σ (N/mm ²)	min.9 (9000kPa)
Transverse tensile strength N (N/mm ²)	min.0,5
Shear resistance τ (N/mm ²)	0,5
Elasticity module E (N/mm ²)	1stc.: 4500 2stc.:4000
Resistance to distributed load kPa	9000
Concentrated load resistance kN	9

Technical characteristics

Fibertherm® wood fiber panel

Characteristics	Value
Density kg/m ³	160
Reaction to fire according to the standard EN 13501-1	E
Coefficient of thermal conductivity λ_D W/(m·K)	0,038
Specific heat J/(kg·K)	2100
Resistance to vapor diffusion μ	5
Value s_d (m)	0,4(80)/0,5(100)/0,6(120)/0,7(140)/0,8(160)
Thermal resistance R_D (m ² ·K)/W	2,10(80) / 2,6(100)/3,15(120) / 3,65(140) / 4,20(160)
Tensile strength perpendicular to the faces (kPa)	≥2,5
Hydraulic resistance relative to the length [(kPa·s)m ²]	≥100
Minimum compressive strength at 10% deformation σ_{10} (N/mm ²)	0,05
Compressive strength (kPa)	50



Beton Wood®

Betontherm fiber dry

Reinforced thermo-acoustic insulation system with BetonWood® cement bonded particle boards and Fibertherm® dry wood fiber

Betontherm fiber dry is the ideal system for creating thermoacoustic coatings with high mechanical resistance and high thermal displacement, for the insulation, both internal and external, of the perimeter walls and suitable for both traditional constructions and dry wood systems (type X-Lam or Platform frame).

It is made from two panels of different thicknesses coupled: one made in **Beton-Wood®** cement bonded particle board and the other in **Fibertherm® dry** wood fiber.

A system designed to offer a simple and effective solution for the creation of a thermal-acoustic insulation system in a short time and without the need for specialized labor. The system provides a high thermal lag thanks to the thermo-acoustic insulation properties of this type of wood fiber.

It is guaranteed by constant checks carried out by external bodies which certify its high quality and, thanks to its high percentage of recycled material (**35%** for cement bonded particle boards and **81%** for wood fiber) it fully complies with the **Minimum Environmental Criteria** and is **CAM** certified.

densities 1350kg/m³ and 110kg/m³



Advantages

- high compression strength;
- resistant to climate change and frost;
- resistant to the external environment;
- insects and fungi are unable to attack or damage it;
- extremely hard and impact resistant;
- incombustible (A2 according to the Standard DIN 4102);
- free from recycled inks, formaldehyde and asbestos, etc.;
- workable with wooden tools;
- creates a healthy and completely natural internal atmosphere;
- recyclable, ecological, respects the environment;

Uses in construction

- ✓ external and internal walls with high thermal displacement;
- ✓ fire resistant ceilings, suspended ceilings and walls;
- ✓ fireproof walls;
- ✓ self-supporting and sound-absorbing walls;
- ✓ load support for walls;
- ✓ insulation walls for highly frequented public places;
- ✓ exhibition stands and prefabricated boxes;
- ✓ road and railway noise barriers;
- ✓ reinforced insulating composite systems;
- ✓ vandal-proof protective coatings;

Available sizes

panels with rabbeted edge

Thickness mm	Size mm	kg/m ²	kg/panel	kg/pallet	panels/pallet	m ² /pallet
22 + 80	1250 x 500	40,70	24,42	537,24	22	13,20
22 + 100	1250 x 500	42,90	25,74	463,32	18	10,80
22 + 120	1250 x 500	45,10	27,06	378,84	14	8,40
22 + 140	1250 x 500	47,30	28,38	340,56	12	7,20
22 + 160	1250 x 500	49,50	29,70	356,40	12	7,20

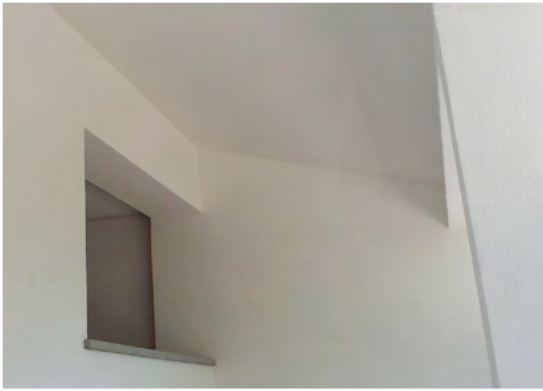

Technical characteristics

BetonWood® cement bonded particle board

Characteristics	Value
Density kg/m ³	1350
Reaction to fire according to the standard EN 13501-1	A2-fl-s1
Coefficient of thermal conductivity λ_D W/(m·K)	0,26
Specific heat J/(kg·K)	1880
Resistance to vapor diffusion μ	22,6
Coefficient of linear thermal expansion α	0,00001
Thick swelling after 24h of permanence in water	1,5%
Change in length and width due to humidity	max 0,3% with temp>20°C and humid. 25% a 90%
Air permeability l/min.m ² MPa	0,133
Surface PH value	11
Flexural strength σ (N/mm ²)	min.9 (9000kPa)
Transverse tensile strength N (N/mm ²)	min.0,5
Shear resistance τ (N/mm ²)	0,5
Elasticity module E (N/mm ²)	1stc.: 4500 2stc.:4000
Resistance to distributed load kPa	9000
Concentrated load resistance kN	9

Technical characteristics

Fibertherm® dry wood fiber panel

Characteristics	Value
Density kg/m ³	110
Reaction to fire according to the standard EN 13501-1	E
Coefficient of thermal conductivity λ_D W/(m·K)	0,037
Specific heat J/(kg·K)	2100
Resistance to vapor diffusion μ	3
Value s_d (m)	0,24(80)/0,3(100)/0,36(120)/0,42(140)/0,48(160)
Thermal resistance R_D (m ² ·K)/W	2,15(80)/2,70(100)/3,20(120)/3,75(140)/4,30(160)
Compression stress for 10% distortion $\bar{\delta}_{10}$ (N/mm ²)	0,05
Compressive strenght (kPa)	50
Tensile strength perpendicular to the faces (kPa)	10
Instant water absorption (kg/m ²)	≤ 1,0



Beton Wood®

Betontherm fiber base

Reinforced thermo-acoustic insulation system with BetonWood® cement bonded particle boards and Fibertherm® base wood fiber

densities 1350kg/m³ and 250kg/m³



Betontherm fiber base is the ideal system for creating thermoacoustic coatings with high mechanical resistance and high thermal displacement, for the insulation, both internal and external, of the perimeter walls and suitable for both traditional constructions and dry wood systems (type X-Lam or Platform frame).

It is made from two panels of different thicknesses coupled: one made in **Beton-Wood®** cement bonded particle board and the other in **Fibertherm®** base wood fiber.



A system designed to offer a simple and effective solution for the creation of a thermal-acoustic insulation system in a short time and without the need for specialized labor. The system provides a high thermal lag thanks to the thermo-acoustic insulation properties of this type of wood fiber.

It is guaranteed by constant checks carried out by external bodies which certify its high quality and, thanks to its high percentage of recycled material (35% for cement bonded particle boards and 91,3% for wood fiber) it fully complies with the **Minimum Environmental Criteria** and is **CAM** certified.



Advantages

- high compression strength;
- resistant to climate change and frost;
- resistant to the external environment;
- insects and fungi are unable to attack or damage it;
- extremely hard and impact resistant;
- incombustible (A2 according to the Standard DIN 4102);
- free from recycled inks, formaldehyde and asbestos, etc.;
- workable with wooden tools;
- creates a healthy and completely natural internal atmosphere;
- recyclable, ecological, respects the environment;

Uses in construction

- ✓ external and internal walls with high thermal displacement;
- ✓ fire resistant ceilings, suspended ceilings and walls;
- ✓ fireproof walls;
- ✓ self-supporting and sound-absorbing walls;
- ✓ load support for walls;
- ✓ insulation walls for highly frequented public places;
- ✓ exhibition stands and prefabricated boxes;
- ✓ road and railway noise barriers;
- ✓ reinforced insulating composite systems;
- ✓ vandal-proof protective coatings;

Available sizes

panels with rabbeted edge

Thickness mm	Size mm	kg/m ²	kg/panel	kg/pallet	panels/pallet	m ² /pallet
22 + 80	1250 x 500	51,90	31,14	685,08	22	13,20
22 + 100	1250 x 500	56,90	34,14	614,52	18	10,80
22 + 120	1250 x 500	61,90	37,14	519,96	14	8,40
22 + 140	1250 x 500	66,90	40,14	481,68	12	7,20
22 + 160	1250 x 500	71,90	43,14	517,68	12	7,20

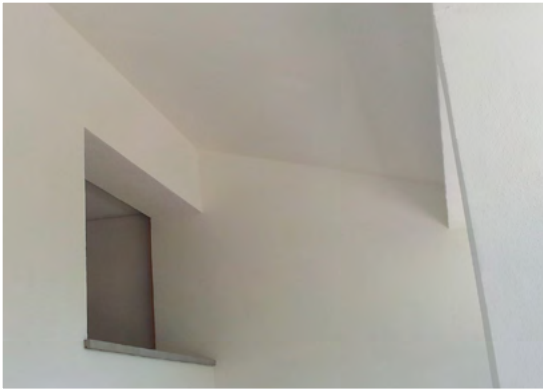

Technical characteristics

BetonWood® cement bonded particle board

Characteristics	Value
Density kg/m ³	1350
Reaction to fire according to the standard EN 13501-1	A2-fl-s1
Coefficient of thermal conductivity λ_D W/(m·K)	0,26
Specific heat J/(kg·K)	1880
Resistance to vapor diffusion μ	22,6
Coefficient of linear thermal expansion α	0,00001
Thick swelling after 24h of permanence in water	1,5%
Change in length and width due to humidity	max 0,3% with temp>20°C and humid. 25% a 90%
Air permeability l/min.m ² MPa	0,133
Surface PH value	11
Flexural strength σ (N/mm ²)	min.9 (9000kPa)
Transverse tensile strength N (N/mm ²)	min.0,5
Shear resistance τ (N/mm ²)	0,5
Elasticity module E (N/mm ²)	1stc.: 4500 2stc.:4000
Resistance to distributed load kPa	9000
Concentrated load resistance kN	9

Technical characteristics

Fibertherm® base wood fiber panel

Characteristics	Value
Density kg/m ³	250
Reaction to fire according to the standard EN 13501-1	E
Coefficient of thermal conductivity λ_D W/(m·K)	0,048
Specific heat J/(kg·K)	2100
Resistance to vapor diffusion μ	5
Value s_d (m)	0,1(20)/0,2(40)/0,3(60)/0,4(80)/0,5(100)
Thermal resistance R_D (m ² ·K)/W	0,40(20)/0,80(40)/1,25(60)/1,65(80)/2,05(100)
Compression stress for 10% distortion δ_{10} (N/mm ²)	≥ 0,15
Compressive strenght (kPa)	≥ 150
Tensile strength perpendicular to the faces (kPa)	≥10
Hydraulic resistance relative to the length [(kPa·s)/m ²]	≥100

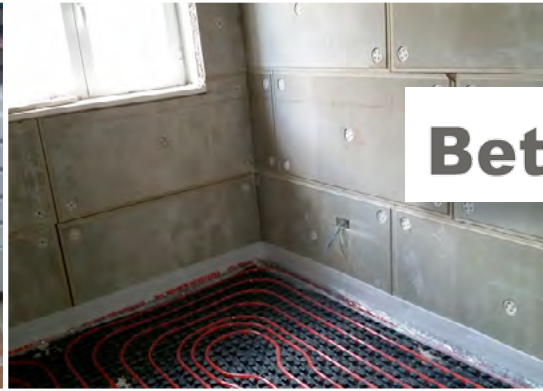
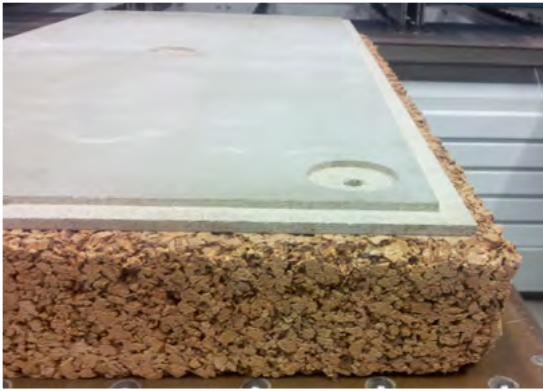

Beton Wood®

Betontherm cork

Reinforced thermo-acoustic insulation system with BetonWood® cement bonded particle boards and Cork Panels compressed blond cork

Betontherm cork is the ideal system for the construction of thermo-acoustic coats with high mechanical resistance and high thermal displacement, for the internal and external insulation of the perimeter walls, and suitable for both traditional constructions and dry wood systems (type X-Lam or Platform frame).

It is made from two panels of different thicknesses coupled: one made in **BetonWood®** cement bonded particle board and the other in **CorkPanels** blond cork.

A system designed to offer a simple and effective solution for the creation of a thermal-acoustic insulation system in a short time and without the need for specialized labor. The blond cork also provides additional protection against mold and moisture thanks to its great breathability.

Quality guaranteed by external bodies that attest to its high quality and, thanks to the high percentage of recycled material (**35%** for cement bonded particle wood and **100%** for blond cork), it complies with the **Minimum Environmental Criteria** and is **CAM** certified.

Advantages

- high compression strength;
- resistant to climate change and frost;
- resistant to the external environment;
- insects and fungi are unable to attack or damage it;
- extremely hard and impact resistant;
- incombustible (A2 according to the Standard DIN 4102);
- free from recycled inks, formaldehyde and asbestos, etc.;
- workable with wooden tools;
- creates a healthy and completely natural internal atmosphere;
- recyclable, ecological, respects the environment;

Available sizes

Thickness mm	Size mm	kg/m ²	kg/panel	kg/pallet	panels/pallet	m ² /pallet
22 + 40	1000 x 500	36,10	18,05	736,44	34	17,00
22 + 60	1000 x 500	39,30	19,65	613,08	26	13,00
22 + 80	1000 x 500	42,50	21,25	516,00	22	11,00
22 + 100	1000 x 500	45,70	22,85	493,56	18	9,00

panels with rabbeted edge

densities 1350kg/m³ and 160kg/m³



Uses in construction

- √ external and internal walls with high thermal displacement;
- √ fire resistant ceilings, suspended ceilings and walls;
- √ fireproof walls;
- √ self-supporting and sound-absorbing walls;
- √ load support for walls;
- √ insulation walls for highly frequented public places;
- √ exhibition stands and prefabricated boxes;
- √ road and railway noise barriers;
- √ reinforced insulating composite systems;
- √ vandal-proof protective coatings;



Technical characteristics

BetonWood® cement bonded particle board

Characteristics	Value
Density kg/m ³	1350
Reaction to fire according to the standard EN 13501-1	A2-fl-s1
Coefficient of thermal conductivity λ_D W/(m·K)	0,26
Specific heat J/(kg·K)	1880
Resistance to vapor diffusion μ	22,6
Coefficient of linear thermal expansion α	0,00001
Thick swelling after 24h of permanence in water	1,5%
Change in length and width due to humidity	max 0,3% with temp>20°C and humid. 25% a 90%
Air permeability l/min.m ² MPa	0,133
Surface PH value	11
Flexural strength σ (N/mm ²)	min.9 (9000kPa)
Transverse tensile strength N (N/mm ²)	min.0,5
Shear resistance τ (N/mm ²)	0,5
Elasticity module E (N/mm ²)	1stc.: 4500 2stc.:4000
Resistance to distributed load kPa	9000
Concentrated load resistance kN	9

Technical characteristics

compressed blond Cork Panels

Characteristics	Value
Density kg/m ³	150±160
Reaction to fire according to the standard EN 13501-1	self-extinguishing class 2
Coefficient of thermal conductivity λ_D W/(m·K)	0,041
Specific heat J/(kg·K)	1674
Resistance to vapor diffusion μ	10±13
Compressive strength at 1mm of deformation σ (kg/cm ²)	0,88
Flexural strength (kPa)	335,39
Compressive strength at 50% deformation σ (kg/cm ²)	12,95
Tensile strength parallel to the faces (kPa)	294,2
Sound absorption power with 3 cm on the external wall (dB)	58
Sound absorption between 800/5000 Hz - thickness 3 cm	0,73



Betontherm styr EPS

Reinforced thermo-acoustic insulation system with BetonWood® cement bonded particle boards and styr EPS 70kPa expanded polystyrene

Betontherm styr EPS is the ideal system for the construction of thermo-acoustic coats with high mechanical resistance and high thermal displacement, for the internal and external insulation of the perimeter walls, and suitable for both traditional constructions and dry wood systems (type X-Lam or Platform frame).

It is made from two panels of different thicknesses coupled: one made in **BetonWood®** cement bonded particle board and the other in **styr EPS 70kPa** expanded polystyrene.

A system designed to offer a simple and effective solution for the creation of a thermo-acoustic insulation system in a short time and without the need for specialized labor. The expanded polystyrene has also an additional resistance against mold and moisture.

Quality guaranteed by external bodies that attest to its high quality and, thanks to the high percentage of recycled material (**35%** for cement bonded particle wood and **100%** for expanded polystyrene), it complies with the **Minimum Environmental Criteria** and is **CAM** certified.

Advantages

- high compression strength;
- resistant to climate change and frost;
- resistant to the external environment;
- insects and fungi are unable to attack or damage it;
- extremely hard and impact resistant;
- incombustible (A2 according to the Standard DIN 4102);
- free from recycled inks, formaldehyde and asbestos, etc.;
- workable with wooden tools;
- creates a healthy and completely natural internal atmosphere;
- recyclable, ecological, respects the environment;

Available sizes

Thickness mm	Size mm	kg/m ²	kg/panel	kg/pallet	panels/pallet	m ² /pallet
22 + 40	1000 x 500	30,70	15,35	521,90	34	17,00
22 + 60	1000 x 500	31,20	15,60	405,60	26	13,00
22 + 80	1000 x 500	31,70	15,85	348,70	22	11,00
22 + 100	1000 x 500	32,20	16,10	289,80	18	9,00
22 + 120	1000 x 500	32,70	16,35	228,90	14	7,00

panels with rabbeted edge

densities 1350kg/m³ and 14÷16kg/m³

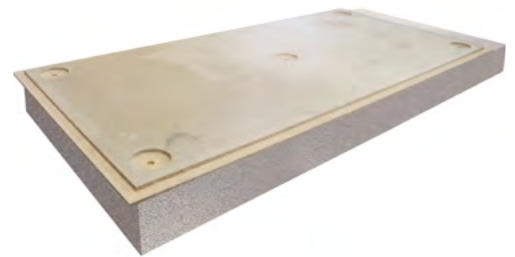

Uses in construction

- √ external and internal walls with high thermal displacement;
- √ fire resistant ceilings, suspended ceilings and walls;
- √ fireproof walls;
- √ self-supporting and sound-absorbing walls;
- √ load support for walls;
- √ insulation walls for highly frequented public places;
- √ exhibition stands and prefabricated boxes;
- √ road and railway noise barriers;
- √ reinforced insulating composite systems;
- √ vandal-proof protective coatings;



Thickness mm	Size mm	kg/m ²	kg/panel	kg/pallet	panels/pallet	m ² /pallet
22 + 140	1000 x 500	33,20	16,60	199,20	12	6,00
22 + 160	1000 x 500	33,70	16,85	202,20	12	6,00

Technical characteristics

BetonWood® cement bonded particle board

Characteristics	Value
Density kg/m ³	1350
Reaction to fire according to the standard EN 13501-1	A2-fl-s1
Coefficient of thermal conductivity λ_D W/(m·K)	0,26
Specific heat J/(kg·K)	1880
Resistance to vapor diffusion μ	22,6
Coefficient of linear thermal expansion α	0,00001
Thick swelling after 24h of permanence in water	1,5%
Change in length and width due to humidity	max 0,3% with temp>20°C and humid. 25% a 90%
Transverse tensile strength N (N/mm ²)	min.0,5
Shear resistance τ (N/mm ²)	0,5
Resistance to distributed load kPa	9000
Concentrated load resistance kN	9

Technical characteristics

EPS 70kPa expanded polystyrene

Characteristics	Value
Density kg/m ³	14+16
Reaction to fire according to the standard EN 13501-1	E
Coefficient of thermal conductivity λ_D W/(m·K)	0,031
Specific heat J/(kg·K)	1450
Resistance to vapor diffusion μ	30
Thermal resistance R_D (m ² ·K)/W	1,30(40)/1,60(50)/1,90(60) /2,55(80)/3,2(100) /3,85(120)/4,50(140)/5,15(160)
Short-term water absorption by partial immersion W_p kg/m ²	≤ 0,5
Flexural strength kPa	≥ 115
Tensile strength perpendicular to the faces kPa	≥ 150
Compressive strength at 10% deformation kPa	70
Shear strength f_{Tk} kPa	0,05



Beton Wood®

Betontherm styr XPS

Reinforced thermo-acoustic insulation system with BetonWood® cement bonded particle boards and styr XPS 300kPa extruded polystyrene

Betontherm styr XPS is the ideal system for the construction of thermo-acoustic coats with high mechanical resistance and high thermal displacement, for the internal and external insulation of the perimeter walls, and suitable for both traditional constructions and dry wood systems (type X-Lam or Platform frame).

It is made from two panels of different thicknesses coupled: one made in **BetonWood®** cement bonded particle board and the other in **styr XPS 300kPa** extruded polystyrene.

A system designed to offer a simple and effective solution for the creation of a thermal-acoustic insulation system in a short time and without the need for specialized labor. The expanded polystyrene has also an additional resistance against mold and moisture.

Quality guaranteed by external bodies that attest to its high quality and, thanks to the high percentage of recycled material (**35%** for cement bonded particle wood and **45%** for extruded polystyrene), it complies with the **Minimum Environmental Criteria** and is **CAM** certified.

Advantages

- high compression strength;
- resistant to climate change and frost;
- resistant to the external environment;
- insects and fungi are unable to attack or damage it;
- extremely hard and impact resistant;
- incombustible (A2 according to the Standard DIN 4102);
- free from recycled inks, formaldehyde and asbestos, etc.;
- workable with wooden tools;
- creates a healthy and completely natural internal atmosphere;
- recyclable, ecological, respects the environment;

densities 1350kg/m³ and 30kg/m³

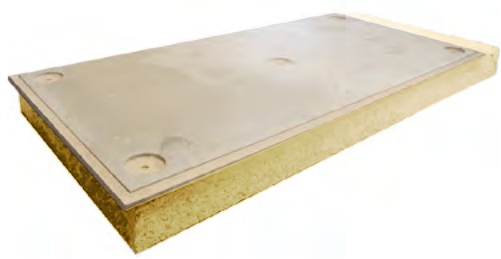

Uses in construction

- √ external and internal walls with high thermal displacement;
- √ fire resistant ceilings, suspended ceilings and walls;
- √ fireproof walls;
- √ self-supporting and sound-absorbing walls;
- √ load support for walls;
- √ insulation walls for highly frequented public places;
- √ exhibition stands and prefabricated boxes;
- √ road and railway noise barriers;
- √ reinforced insulating composite systems;
- √ vandal-proof protective coatings;

Available sizes

panels with rabbeted edge

Thickness mm	Size mm	kg/m ²	kg/panel	kg/pallet	panels/pallet	m ² /pallet
22 + 40	1200 x 500	30,70	18,42	626,28	34	20,40
22 + 60	1200 x 500	31,20	18,72	486,72	26	15,60
22 + 80	1200 x 500	31,70	19,02	418,44	22	13,20
22 + 100	1200 x 500	32,20	19,32	347,76	18	10,80
22 + 120	1200 x 500	32,70	19,62	274,68	14	8,40
22 + 140	1200 x 500	33,20	19,92	239,04	12	7,20
22 + 160	1200 x 500	33,70	20,22	242,62	12	7,20

Technical characteristics

BetonWood® cement bonded particle board

Characteristics	Value
Density kg/m ³	1350
Reaction to fire according to the standard EN 13501-1	A2-fl-s1
Coefficient of thermal conductivity λ_D W/(m·K)	0,26
Specific heat J/(kg·K)	1880
Resistance to vapor diffusion μ	22,6
Coefficient of linear thermal expansion α	0,00001
Thick swelling after 24h of permanence in water	1,5%
Change in length and width due to humidity	max 0,3% with temp>20°C and humid. 25% a 90%
Air permeability l/min.m ² MPa	0,133
Surface PH value	11
Flexural strength σ (N/mm ²)	min.9 (9000kPa)
Transverse tensile strength N (N/mm ²)	min.0,5
Shear resistance τ (N/mm ²)	0,5
Elasticity module E (N/mm ²)	1stc.: 4500 2stc.:4000
Resistance to distributed load kPa	9000
Concentrated load resistance kN	9



Technical characteristics

XPS 300kPa extruded polystyrene

Characteristics	Value
Density kg/m ³	30
Reaction to fire according to the standard EN 13501-1	E
Specific heat J/(kg·K)	1450
Coefficient of thermal conductivity λ_D W/(m·K)	0,033(40)/0,034(60)/0,035(80 ÷ 160)
Thermal resistance R _D (m ² ·K)/W	1,25(40)/1,80(60)/2,30(80)/ 2,85(100)/3,45(120) /4,00(140)/4,60(160)
Resistance to vapor diffusion μ	100
Short-term compressive strength (for a deformation of 10%) (kPa)	≥ 300
Deformation under load and temperature (40 kPa -70°C - 168 hours) (%)	≤ 5
Elasticity module (kPa)	16.000
Long-term water absorption rate by total immersion (28 days) (%)	≤ 1,5
Dimensional stability (70°C/90°C - 90% UR, 48 hours) (%)	≤ 5
Tensile strength perpendicular to the two faces (kPa)	≥ 200
Coefficient of linear thermal expansion (mm/mK)	0,07



Betontherm strong

Reinforced thermo-acoustic insulation system with BetonWood® cement bonded particle boards and extruded polystyrene 700kPa

Betontherm strong is the ideal system for the construction of thermo-acoustic coats with high mechanical resistance and high thermal displacement, for the internal and external insulation of the perimeter walls, and suitable for both traditional constructions and dry wood systems (type X-Lam or Platform frame).

It is made from two panels of different thicknesses coupled: one made in **BetonWood®** cement bonded particle board and the other in **strong 700kPa** extruded polystyrene.

A system designed to offer a simple and effective solution for the creation of a thermo-acoustic insulation system in a short time and without the need for specialized labor. The expanded polystyrene has also an additional resistance against mold and moisture.

Quality guaranteed by external bodies that attest to its high quality and, thanks to the high percentage of recycled material (**35%** for cement bonded particle wood and **10%** for extruded polystyrene), it complies with the **Minimum Environmental Criteria** and is **CAM** certified.

Advantages

- high compression strength;
- resistant to climate change and frost;
- resistant to the external environment;
- insects and fungi are unable to attack or damage it;
- extremely hard and impact resistant;
- incombustible (A2 according to the Standard DIN 4102);
- free from recycled inks, formaldehyde and asbestos, etc.;
- workable with wooden tools;
- creates a healthy and completely natural internal atmosphere;
- recyclable, ecological, respects the environment;

densities 1350kg/m³ and 40kg/m³



Uses in construction

- ✓ external and internal walls with high thermal displacement;
- ✓ fire resistant ceilings, suspended ceilings and walls;
- ✓ fireproof walls;
- ✓ self-supporting and sound-absorbing walls;
- ✓ load support for walls;
- ✓ insulation walls for highly frequented public places;
- ✓ exhibition stands and prefabricated boxes;
- ✓ road and railway noise barriers;
- ✓ reinforced insulating composite systems;
- ✓ vandal-proof protective coatings;

Available sizes

panels with rabbeted edge

Thickness mm	Size mm	kg/m ²	kg/panel	kg/pallet	panels/pallet	m ² /pallet
22 + 50	1200 x 500	31,70	19,02	570,60	30	18,00
22 + 60	1200 x 500	32,10	19,26	500,76	26	15,60
22 + 80	1200 x 500	32,90	19,74	394,80	20	12,00
22 + 100	1200 x 500	33,70	20,22	323,52	16	9,60
22 + 120	1200 x 500	34,50	20,70	289,80	14	8,40
22 + 140	1200 x 500	35,30	21,18	254,26	12	7,20
22 + 160	1200 x 500	36,10	21,66	259,92	12	7,20
22 + 180	1200 x 500	36,90	22,14	221,40	10	6,00
22 + 200	1200 x 500	37,70	22,62	180,96	8	4,80

Technical characteristics

BetonWood® cement bonded particle board

Characteristics	Value
Density kg/m ³	1350
Reaction to fire according to the standard EN 13501-1	A2-fl-s1
Coefficient of thermal conductivity λ_D W/(m·K)	0,26
Specific heat J/(kg·K)	1880
Resistance to vapor diffusion μ	22,6
Coefficient of linear thermal expansion α	0,00001
Thick swelling after 24h of permanence in water	1,5%
Change in length and width due to humidity	max 0,3% with temp>20°C and humid. 25% a 90%
Air permeability l/min.m ² MPa	0,133
Surface PH value	11
Flexural strength σ (N/mm ²)	min.9 (9000kPa)
Transverse tensile strength N (N/mm ²)	min.0,5
Shear resistance τ (N/mm ²)	0,5
Elasticity module E (N/mm ²)	1stc.: 4500 2stc.:4000
Resistance to distributed load kPa	9000
Concentrated load resistance kN	9



Technical characteristics

strong 700kPa extruded polystyrene

Characteristics	Value
Density kg/m ³	40
Reaction to fire according to the standard EN 13501-1	E
Specific heat J/(kg·K)	1450
Coefficient of thermal conductivity λ_D W/(m·K)	0,034(50,60,120)/0,035(80,160)/0,036(100,180,200)
Thermal resistance R_D (m ² ·K)/W	1,50(50)/1,80(60)/2,30(80)/2,80(100)/3,55(120) /4,05(140)/4,60(160)/5,05(180)/5,60(200)
Resistance to vapor diffusion μ	100
Short-term compressive strength (for a deformation of 10%) (kPa)	≥ 700
Deformation under load and temperature (40 kPa -70°C - 168 hours) (%)	≤ 5
Elasticity module (kPa)	30.000
Long-term water absorption rate by total immersion (28 days) (%)	0,3 - 0,4
Dimensional stability (70°C/90°C - 90% UR, 48 hours) (%)	≤ 5
Tensile strength perpendicular to the two faces (kPa)	200
Resistance to freeze-thaw cycles after water absorption by long-term diffusion (%vol.)	≤ 1
Resistance to freeze-thaw cycles after long-term water absorption by total immersion (%vol.)	≤ 1



Storage & transport

Packaging of BetonWood® panels

The product is packed on pallets or wooden beams directly in the factory.

A protective layer of lower category chipboard or cement bonded particle board is placed on the top and bottom of each pallet. The pallets of panels are blocked by special plastic straps, and the edges of the cement bonded particle boards under them are protected.

The total weight of a standard pallet is approximately 3200/3500 kg.

The total weight of a **BetonWood®** pallet, on the other hand, is approximately 1000 kg.

Transport precautions

Pallets are normally delivered by truck or courier.

Given the high mass of the pallets, it is advisable for the recipient to have suitable equipment and mechanical lifting means with maximum capacities of 3500 / 4000kg for unloading the goods.

Further transport or unloading must be regulated and organized by the customer himself / with collection from our warehouses or with delivery by courier.

Deposit of BetonWood® panels

Correct storage is essential for the correct conservation of the material:

- it is advisable to position the panels one on top of the other in order to keep them in a horizontal position, with square section supports and a minimum spacing of 80 cm. Avoid bowing with intermediate supports (see figure).
- the panels must be supported for their total length by wooden beams positioned in at least four points at a uniform distance. The maximum center distance between the wooden supports must be no more than 800 mm.
- when handling the BetonWood® panels individually, it is recommended to take them by cutting, never horizontally, just like a sheet of glass (see figure).
- the pallet must be protected with suitable sheets to avoid the accumulation of dust and avoid contact with moisture from the ground and rain.
- after having partially used the pallet panels, the protective chipboard panel must be restored and a ballast must be positioned on the upper side of the remaining panels to avoid distortion of the upper panels.
- avoid storing the panels by placing them on the edge (see figure).
- avoid direct exposure of the panels to sunlight during storage.

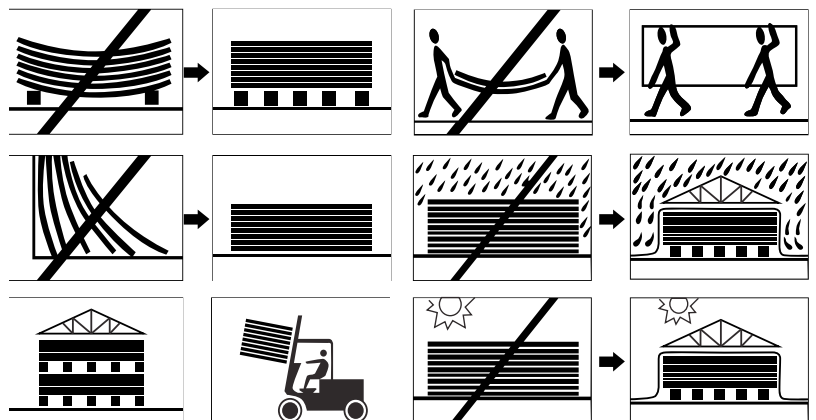



Installation of Betontherm systems

The system includes

- √ pannelli del sistema **Betontherm**, modulari, realizzati da due pannelli accoppiati in fabbrica: un pannello in cementolegno tipo **BetonWood**® spessore 22 (densità 1350kg/m³) che costituisce lo strato ad elevata resistenza meccanica ed elevata densità, ed uno in materiale altamente isolante (a scelta fra quelli elencati) che garantisce un elevato sfasamento termico ed abbattimento acustico;
- √ tasselli idonei per questo tipo di sistema e dotati di tappo di protezione anti-ponte termico;
- √ rete BetonNet densità 360g/m³ ed accessori;
- √ rasanti e finiture idonee per la tipologia di superficie.

Per informarsi sulle tipologie di pannello **Betontherm** e di accessori in base alle vostre esigenze, vi preghiamo di contattare il nostro **ufficio tecnico** all'indirizzo info@betonwood.com.

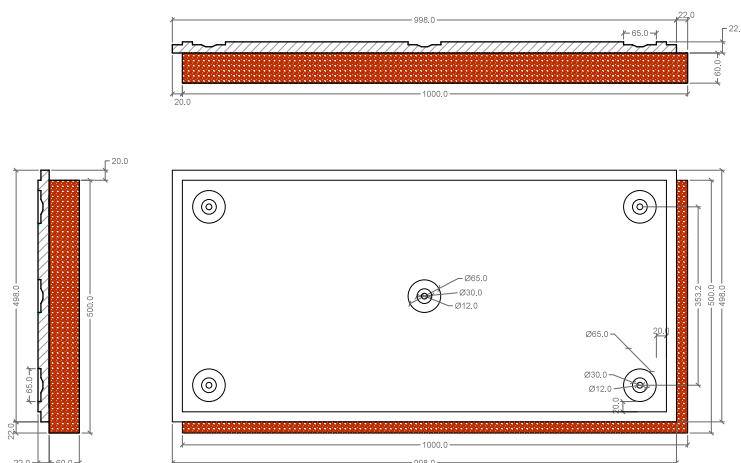

Figure 13 Technical drawing of the Betontherm cork panel

The panels positioning

Una volta che si è controllato il sottostrato (vedi le specifiche di posa spiegate sulle nostre **Istruzioni di posa**) si procede posizionando la prima fila di pannelli Betontherm. I pannelli devono essere disposti in senso orizzontale (come in figura) e devono essere installati partendo dalla base inferiore della parete e proseguendo verso l'alto.

In caso di ambienti particolarmente umidi, oppure in caso di cappotto esterno con fibra di legno a contatto col terreno, si consiglia caldamente di posare una prima striscia di base in polistirene estruso XPS.

In questo modo il sistema è impermeabile all'acqua di risalita.

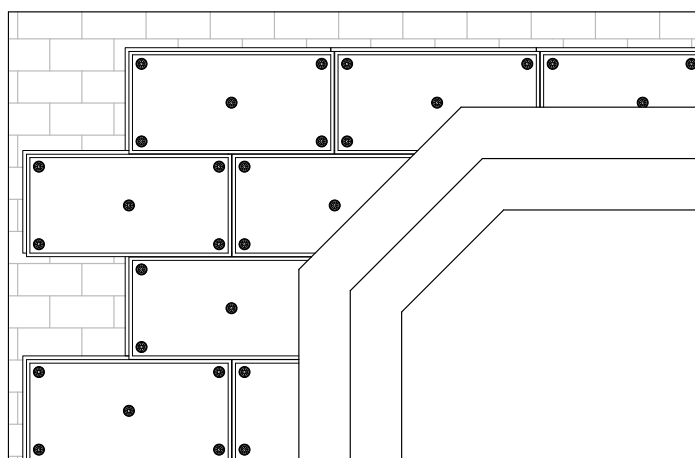



The dowel fixing

Specifically, the positioning of **Betontherm** modular panels for reinforced thermal insulation systems must be carried out in the following steps:

- lay the panels with staggered joints starting from the starting profile, without the use of glue, but using the interlocking of the rebated edges of the **Betontherm** panels;
- leaning the **Betontherm** panel against the wall and with a drill (8 mm tip) drill the underlying wall in correspondence with the special housings for the **Betonfix** mushroom plugs milled on the panel;
- clean the dowel housing with compressed air before inserting the **Betonfix** mushroom dowel for masonry;
- anchor the panel to the wall by inserting the dowels and screwing the element that protrudes from the mushroom head with the drill (attention: do not use hammer drills on perforated walls);
- when installing adjacent **Betontherm** panels, pay close attention to ensure that the insulating layer of one panel adheres well to the other, so that the edges coincide perfectly;
- to form the corners of the **Betontherm** reinforced thermal coat, please use special panels with pre-cut insulation, making sure that the cement bonded particle board always overlaps the insulating layer;
- in the case of cut **Betontherm** panels, and therefore without housing for dowels, a cutter will be provided on loan for use to create housings directly on site.

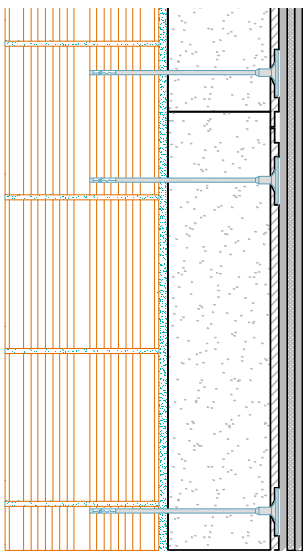

Figure 15 Betontherm stratigraphy on masonry



Betonfix Termoz 6H

Dowels for fixing Betontherm on solid wood structures and wood panels.



Betonfix FIF-CS8

Dowels for fixing Betontherm on concrete and masonry.



Figure 16 Corners of the Betontherm system





Joint's reinforcement and skimming

After fixing the **Betontherm** thermal insulation panels, you can proceed with the reinforcement of the joints between the panels by covering the pre-milled lowered edges with **BetonNet strip adhesive tape** (shown in the figure).

La sovrapposizione del nastro coprigiunto deve essere almeno di 10 cm.

The overlap of the joint cover tape must be at least 10 cm.

Once the joints have been reinforced, skim and grout the plugs and corners (internal and external) with a two-component polyurethane adhesive highly recommended by us, **Mapelastic**, a two-component elastic cementitious mortar that must be applied on site within 60 minutes of mixing.

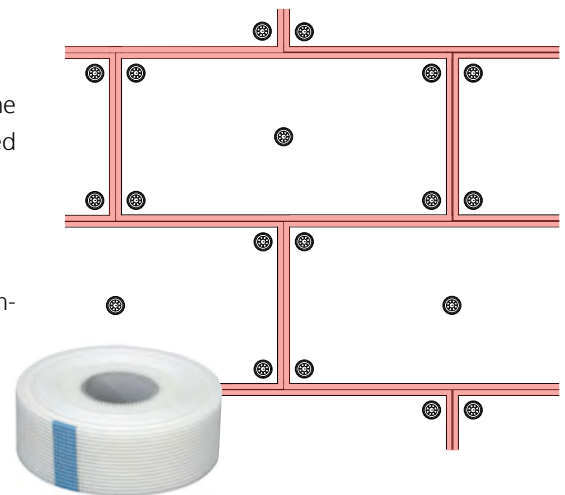

Accessories's installation and skimming

Please pay the utmost attention to the care of the joining parts between **Betontherm** thermal insulation panels and the components present on the facade (doors, windows, projections, expansion joints of the building, corners, etc.) and use accessories and angles suitable for the installation of this type of system in order to complete the execution in a workmanlike manner:

- cover the corners with **Betoncorner Alu**;
- cover the edges of windows and doors with the preformed accessory **Betoncorner Alu**;
- use the corner drip stop **Betondrip starter PVC** (shown in the figure) as a starting point for laying the first rows of insulation system;
- the system does not require thermal expansion joints, but if they are present in the building these must be respected.

For skimming, spread the single-component cementitious mortar such as **Beton AR1** in a uniform thickness and incorporate the glass fiber net 360 gr/m² **BetonNet glass 360**.

The **BetonNet glass 360** net must be unrolled from top to bottom and crushed with a smooth spatula on the fresh layer of the mixture. In the joints it must overlap by at least 10 cm.

A compact and regular surface is obtained, suitable for receiving the finishing coating which must be applied only when the smoothing compound is well hardened and cured.

The single-component cementitious mortar type **Beton AR1** can be applied vertically without pouring and without letting the insulating panels slip, even if of large dimensions (consumption 1.3-1.5 kg/m² per mm of thickness).

Apply the second layer of skimming compound according to the same instructions. It is recommended not to exceed a thickness of 2 mm for the smoothing layer.

For more detailed information, contact our technical department at info@betonwood.com

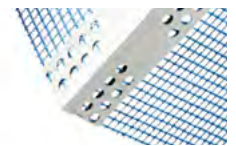

Betoncorner Alu

Angular glass fiber net with density of 165 g/m² reinforced with a 90° aluminum profile.

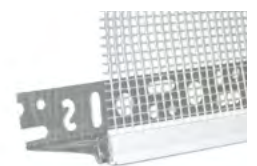

Betondrip starter PVC

Drip tray with 165 g/m² density fiberglass net.



BetonNet glass 360

Glass fiber net with 360 g/m² density ideal to reinforced thermal insulating composite systems.



Corkpanels

Compressed blond cork panel for thermal insulating wall systems

density 150÷160 kg/m³

The blond **Cork Panels** is a compressed panel which is directly plasterable and it is ideal to be an excellent thermal insulating system of internal and external partition and perimeter walls. It is a very valid screen from electromagnetic waves, it is breathable and permeable to vapor, it does not undergo dimensional changes and is unassailable by most acid agents, including gastric acids, and this makes it indigestible to insects, rodents and birds. It avoids the formation of mold or condensation and allows to obtain high insulating values with reduced thickness.

Produced in emission class A + according to the French decree for indoor emissions. Suitable for application in the public sphere according to the **CAM Directives Minimum Environmental Criteria** of the Ministerial Decree of 24.12.2015 and following.



Advantages

- plasterable insulating panel in natural blond cork;
- excellent thermal insulation and noise reduction;
- permeable and breathable, resistant to mold and condensation;
- significantly reduces structural thermal bridges;
- it is resistant to acid agents, insects, rodents and birds;
- high compressive strength;
- excellent thermal insulation and breathability values;
- favors the reduction of CO₂ emissions, and improves air quality;
- light, particularly easy processing;
- recyclable, ecological, respects the environment.



Uses in construction

- ✓ External thermal insulation system;
- ✓ Internal thermal insulation system;
- ✓ Insulation of wood, stone walls and masonry;
- ✓ Thermo-acoustic insulation of wood structures (X-Lam);
- ✓ Thermo-acoustic insulation of metal frame structures;
- ✓ Insulation of internal partitions.

Available sizes

sharp edge's panels

Thickness mm	Size mm	kg/panel	panels/pallet	m ² /pallet	kg/pallet
20	1000 x 500	1,60	15	7,5	approx. 24
30	1000 x 500	2,32	10	5	approx. 23,2
40	1000 x 500	3,10	8	5	approx.24,8
50	1000 x 500	3,87	6	3	approx.23,2
60	1000 x 500	4,65	5	2,5	approx.23,2
80	1000 x 500	6,20	4	2	approx.24,8
100	1000 x 500	13,20	3	1,5	approx.39,6



Technical characteristics

Characteristics	Value
Manufacturing controlled according to the standard	EN-13171
Density kg/m ³	150÷160
Reaction to fire according to the standard EN 13501-1	self-extinguishing class 2
Coefficient of thermal conductivity λ_0 W/(m·K)	0,041
Specific heat J/(kg·K)	1674
Resistance to vapor diffusion μ	10÷13
Compressive strength at 1mm of deformation σ (kg/cm ²)	0,88
Flexural strength (kg/cm ²)	3,42
Compressive strength at 50% deformation σ (kg/cm ²)	12,95
Tensile strength parallel to the faces (kPa)	3
Sound absorption power with 3 cm on the external wall (dB)	58
Sound absorption power with 4 cm on the external wall (dB)	52
Sound absorption between 800/5000 Hz - thickness 3 cm	0,73



Corkpanels L

Compressed blond cork panel for thermal insulating wall systems

density 150÷180 kg/m³

The blond **Cork Panels L** is a compressed panel which is directly plasterable and it is ideal to be an excellent thermal insulating system of internal and external partition and perimeter walls. It is a very valid screen from electromagnetic waves, it is breathable and permeable to vapor, it does not undergo dimensional changes and is unassailable by most acid agents, including gastric acids, and this makes it indigestible to insects, rodents and birds. It avoids the formation of mold or condensation and allows to obtain high insulating values with reduced thickness.

Produced in emission class A + according to the French decree for indoor emissions. Suitable for application in the public sphere according to the **CAM Directives Minimum Environmental Criteria** of the Ministerial Decree of 24.12.2015 and following.



Advantages

- plasterable insulating panel in natural blond cork;
- excellent thermal insulation and noise reduction;
- permeable and breathable, resistant to mold and condensation;
- significantly reduces structural thermal bridges;
- it is resistant to acid agents, insects, rodents and birds;
- high compressive strength;
- excellent thermal insulation and breathability values;
- favors the reduction of CO₂ emissions, and improves air quality;
- light, particularly easy processing;
- recyclable, ecological, respects the environment.



Uses in construction

- ✓ External thermal insulation system;
- ✓ Internal thermal insulation system;
- ✓ Insulation of wood, stone walls and masonry;
- ✓ Thermo-acoustic insulation of wood structures (X-Lam);
- ✓ Thermo-acoustic insulation of metal frame structures;
- ✓ Insulation of internal partitions.

Available sizes

sharp edge's panels

Thickness mm	Size mm	kg/panel	panels/pallet	m ² /pallet	kg/pallet
10	1030 x 590	1,09	150	91,16	approx. 160
20	1030 x 590	2,19	144	69,28	approx. 249
30	1030 x 590	3,28	76	46,19	approx.249
40	1030 x 590	4,38	58	35,25	approx.254
50	1030 x 590	5,47	46	27,95	approx.251
60	1030 x 590	6,56	38	23,09	approx.249
70	1030 x 590	7,66	32	19,45	approx.245



Thickness mm	Size mm	kg/panel	panels/pallet	m ² /pallet	kg/pallet
80	1030 x 590	8,75	28	17,02	approx.245
90	1030 x 590	9,84	26	15,80	approx.255
100	1030 x 590	10,94	22	13,37	approx.240

Technical characteristics

Characteristics	Value
Manufacturing controlled according to the standard	EN-13171
Density kg/m ³	150÷180
Reaction to fire according to the standard EN 13501-1	self-extinguishing class 2
Coefficient of thermal conductivity λ_D W/(m·K)	0,043
Specific heat J/(kg·K)	1900 - 2100 (a 20°)
Resistance to vapor diffusion μ	10
Thermal resistance R (m ² /cm ²)	0,23(10)/0,46(20)/0,69(30)/0,93(40)/1,16(50) 1,39(60)/1,62(70)/1,86(80)/2,09(90)/2,32(100)
Thermal transmittance U W(m ² K)	4,3(10)/2,1(20)/1,4(30)/1,07(40)/0,86(50) 0,71(60)/0,61(70)/0,53(80)/0,47(90)/0,43(100)
Compressive strenght (kg/cm ²)	4 ÷ 6
Compression tension with shortening of the 10% (N/mm ²)	0,22
Vertical tensile strength (N/mm ²)	0,16
Speed of sound propagation through the panel (m/s)	450 - 500
Airborne noise reduction, with a thickness of 3 cm (dB)	32 - 35

Fibertherm® protect

Wood fiber panel for thermal insulating wall systems

Wet produced

densities 230 - 265 kg/m³

The **Fibertherm® protect** wood fiber panel is a directly plasterable panel for thermal insulation of internal and external partition and perimeter walls. It has medium density, low thermal conductivity, high compressive strength and is water repellent. **Fibertherm® protect** is permeable, e.g. steamed, and allows the regulation of humidity. Facade insulation protects the house like a good functional coat. The wall remains breathable and at the same time minimizes the loss of thermal energy in a sustainable way.

It is guaranteed by constant checks carried out by external bodies which certify its high quality and, thanks to its high percentage of recycled material (**91,3%**), it fully complies with the **Minimum Environmental Criteria** and it is **CAM** certified.



Advantages

- plasterable insulating panel in wood fiber;
- robust and long-lasting insulating panels in natural wood fiber;
- permeable and breathable but at the same time water repellent;
- significantly reduces structural thermal bridges;
- protects from heat and cold, and has good sound insulation;
- protects the climate in a sustainable way thanks to the absorption of CO₂;
- almost unlimited design options thanks to different plastering systems;
- high safety thanks to the special male-female profile which contributes to the hermetic closure of the construction;
- light, particularly easy processing;
- recyclable, ecological, respects the environment.



Uses in construction

- ✓ External thermal insulation system;
- ✓ Internal thermal insulation system;
- ✓ Insulation of wood, stone walls and masonry;
- ✓ Thermo-acoustic insulation of wood structures (X-Lam);
- ✓ Thermo-acoustic insulation of metal frame structures;
- ✓ Insulation of internal partitions.

Available sizes

tongue&groove edge's panels - 230kg/m³

Thickness mm	Size mm	Real surface mm	kg/m ²	panels/pallet	m ² /panels	kg/pallet
80	1325 x 600	1300 x 575	18,44	28	22,26	approx. 420
100	1325 x 600	1300 x 575	23,00	22	17,49	approx. 413

tongue&groove edge's panels - 230kg/m³

Thickness mm	Size mm	Real surface mm	kg/m ²	panels/pallet	m ² /panels	kg/pallet
80	2625 x 1175	2600 x 1150	16,80	14	43,18	approx. 744



Available sizes

sharp edge's panels - 230kg/m³

Thickness mm	Size mm	kg/m ²	panels/pallet	m ² /panels	kg/pallet
80	2800 x 1250	16,80	14	49,0	approx. 823
100	2800 x 1250	28,20	11	38,5	approx. 920

tongue&groove edge's panels - 265kg/m³

Thickness mm	Size mm	Real surface mm	kg/m ²	panels/pallet	m ² /panels	kg/pallet
40	1325 x 600	1300 x 575	10,60	56	44,52	approx. 482
60	1325 x 600	1300 x 575	15,90	38	30,21	approx. 490

Thickness mm	Size mm	Real surface mm	kg/m ²	panels/pallet	m ² /panels	kg/pallet
40	2625 x 1175	2600 x 1150	10,60	28	86,36	approx.926
60	2625 x 1175	2600 x 1150	15,90	19	58,60	approx.942

sharp edge's panels - 265kg/m³

Thickness mm	Size mm	kg/m ²	panels/pallet	m ² /panels	kg/pallet
40	2800 x 1250	10,60	28	98,00	approx.1049
60	2800 x 1250	15,90	19	66,50	approx.1070

Thickness mm	Size mm	kg/m ²	panels/pallet	m ² /panels	kg/pallet
20	1350 x 500	5,30	112	75,60	approx.400

Technical characteristics

Characteristics	Value
Manufacturing controlled according to the standard	EN-13171
Reaction to fire according to the standard EN 13501-1	E
Density kg/m ³	230 - 265
Coefficient of thermal conductivity λ_D W/(m·K)	0,046(230) - 0,048(265)
Specific heat J/(kg·K)	2100
Resistance to vapor diffusion μ	5
Value s_d (m)	0.20(40mm)/0.30(60mm)/0.40(80mm)
Thermal resistance R_D (m ² ·K)/W	0.80 (40mm)/1.25 (60mm)/1.70 (80mm)
Tolerance of perpendicularity according to EN 824	3mm/m
Compressive strenght (kPa)	100(230) - 180(265)
Tensile strenght (kPa)	15(230) - 20(265)



Fibertherm® protect dry

Wood fiber panel for thermal insulating wall systems

Dry produced

densities 110 - 140 - 180 kg/m³

The **Fibertherm® protect dry** wood fiber panel is a directly plasterable panel for thermal insulation of internal and external partition and perimeter walls. It has medium density, low thermal conductivity, medium compressive strength and is water repellent.

Fibertherm® protect dry is permeable, e.g. steamed, and allows the regulation of humidity. Facade insulation protects the house like a good functional coat. The wall remains breathable and at the same time minimizes the loss of thermal energy in a sustainable way.

It is guaranteed by constant checks carried out by external bodies which certify its high quality and, thanks to its high percentage of recycled material (**86%**), it fully complies with the **Minimum Environmental Criteria** and it is **CAM** certified.



Advantages

- plasterable insulating panel in wood fiber;
- robust and long-lasting insulating panels in natural wood fiber;
- permeable and breathable but at the same time water repellent;
- significantly reduces structural thermal bridges;
- protects from heat and cold, and has good sound insulation;
- protects the climate in a sustainable way thanks to the absorption of CO₂;
- almost unlimited design options thanks to different plastering systems;
- high safety thanks to the special male-female profile which contributes to the hermetic closure of the construction;
- light, particularly easy processing;
- recyclable, ecological, respects the environment.



Uses in construction

- ✓ External thermal insulation system;
- ✓ Internal thermal insulation system;
- ✓ Insulation of wood, stone walls and masonry;
- ✓ Thermo-acoustic insulation of wood structures (X-Lam);
- ✓ Thermo-acoustic insulation of metal frame structures;
- ✓ Insulation of internal partitions.

Available sizes

sharp edge's panels - 110kg/m³

Thickness mm	Size mm	kg/m ²	panels/pallet	m ² /panels	kg/pallet
140	600 x 400	15,40	32	7,7	approx. 129
160	600 x 400	17,60	28	6,7	approx. 128
180	600 x 400	19,80	24	5,8	approx. 125
200	600 x 400	22,00	24	5,8	approx. 138



Available sizes

sharp edge's panels - 110kg/m³

Thickness mm	Size mm	kg/m ²	panels/pallet	m ² /panels	kg/pallet
100	1200 x 400	11,00	22	10,60	approx. 127
120	1200 x 400	13,20	18	8,6	approx. 124
140	1200 x 400	15,40	16	7,7	approx. 129
160	1200 x 400	17,60	14	6,7	approx. 128
180	1200 x 400	19,80	12	5,8	approx. 125
200	1200 x 400	22,00	12	5,8	approx. 138
220	1200 x 400	24,20	10	4,8	approx. 126
240	1200 x 400	26,40	10	4,8	approx. 137

tongue&groove edge's panels - 140kg/m³

Thickness mm	Size mm	Real surface mm	kg/m ²	panels/pallet	m ² /panels	kg/pallet
60	1325 x 600	1300 x 575	8,40	38	30,21	approx. 281
80	1325 x 600	1300 x 575	11,20	28	22,26	approx. 270
100	1325 x 600	1300 x 575	14,00	22	17,49	approx. 261
120	1325 x 600	1300 x 575	16,80	18	14,31	approx. 260
140	1325 x 600	1300 x 575	19,60	16	12,72	approx. 269
160	1325 x 600	1300 x 575	22,40	14	11,13	approx. 269
180	1325 x 600	1300 x 575	25,20	12	9,54	approx. 260
200	1325 x 600	1300 x 575	28,00	12	9,54	approx. 278

sharp edge's panels - 140kg/m³

Thickness mm	Size mm	kg/m ²	panels/pallet	m ² /panels	kg/pallet
60	2800 x 1250	11,00	19	66,50	approx. 568
80	2800 x 1250	11,00	14	49,00	approx. 593
100	2800 x 1250	11,00	11	38,50	approx. 575
120	2800 x 1250	13,20	9	31,50	approx. 426
140	2800 x 1250	15,40	8	28,00	approx. 430
160	2800 x 1250	17,60	7	24,50	approx. 430

tongue&groove edge's panels - 180kg/m³

Thickness mm	Size mm	Real surface mm	kg/m ²	panels/pallet	m ² /panels	kg/pallet
40	1325 x 600	1300 x 575	7,20	56	44,52	approx. 320
60	1325 x 600	1300 x 575	10,80	38	30,21	approx. 326



Beton Wood®

Available sizes

sharp edge's panels - 180kg/m³

Thickness mm	Size mm	kg/m ²	panels/pallet	m ² /panels	kg/pallet
40	2800 x 1250	7,20	28	98,00	approx. 705
60	2800 x 1250	10,80	19	66,50	approx. 718

Technical characteristics

Characteristics	Value
Manufacturing controlled according to the standard	EN-13171
Identification code	110 kg/m ³ 140 kg/m ³ 180 kg/m ³ WF-EN 13171-T5-DS(70 \90)3-CS(10 \Y)50 - TR 10 - WS1,0 - MU3 WF-EN 13171-T5-DS(70 \90)3-CS(10\Y)100 - TR 20 - WS1,0 - MU3 WF-EN 13171-T5-DS(70 \90)3-CS(10\Y)200 - TR 30 - WS1,0 - MU3
Reaction to fire according to the standard EN 13501-1	E
Density kg/m ³	110 - 140 - 180
Coefficient of thermal conductivity λ_D W/(m·K)	0,037(110) - 0,040(140) - 0,043(180)
Specific heat J/(kg·K)	2100
Resistance to vapor diffusion μ	3
Compressive strenght (kPa)	50(110) - 100(140) - 200(180)
Tensile strenght (kPa)	10(110) - 20(140) - 30(180)
Dimensional stability 48h, 70°C, 90% relative humidity	length $\Delta\epsilon_l \leq 3\%$ width $\Delta\epsilon_b \leq 3\%$ thickness $\Delta\epsilon_d \leq 3\%$
Components	wood fibers, paraffin
Waste code (EAK)	030105 /170201



Fibertherm® internal

Wood fiber panel for internal insulating wall systems

Wet produced

density 160 kg/m³



The **Fibertherm® internal** wood fiber panel is a plasterable panel for thermal insulation of internal walls and partitions. The panels have reduced thicknesses to take up as little space as possible, high compressive strength and are water repellent.

The ecological insulating panel for internal thermal coats **Fibertherm® internal** saves energy and improves the internal environmental comfort.

The practical insulating panels in wood fiber are open to the diffusion of steam and allow the capillary transport of moisture. In this way, **Fibertherm® internal** also actively protects against the formation of mold in inhabited areas because the buffering of humidity and its active transport create a balance that does not allow mold to grow and proliferate.



It can also be used for the insulation of external walls in combination with **Beton-Wood cement bonded particle boards**.



It is guaranteed by constant checks carried out by external bodies which certify its high quality and, thanks to its high percentage of recycled material (**91,3%**), it fully complies with the **Minimum Environmental Criteria** and it is **CAM** certified.

Advantages

- reduced thicknesses to take up as little space as possible;
- effective protection against summer heat and winter frost;
- dermatologically tested, with no adverse effects on the skin;
- made using the wet method;
- considerable thermal and acoustic insulation;
- open to the diffusion of water vapor;
- high capacity to absorb ambient humidity, which it constitutes a natural system of hygrometric regulator;
- can be used without additional anti-vapor layers;
- creates a healthy and completely natural internal atmosphere;
- recyclable, ecological, respects the environment;
- construction material tested and authorized according to the European standards in force.

Uses in construction

- ✓ Internal insulation of the perimeter walls;
- ✓ Active breathable internal insulation in combination with lime and clay plaster;
- ✓ Internal thermal insulation system;
- ✓ Ceiling insulation;
- ✓ Insulation for external walls as long as it remains covered with BetonWood cement bonded particle board or rainproof coating;
- ✓ Thermal-acoustic insulation of wooden structures (X-Lam);
- ✓ Thermal-acoustic insulation of metal frame structures;
- ✓ Insulation of internal partitions.



Available sizes

sharp edge's panels

Thickness mm	Size mm	kg/m ²	panels/pallet	m ² /panels	kg/pallet
40	1200 x 380	3,20	116	94,0	approx. 300
60	1200 x 380	4,80	74	59,9	approx. 300
80	1200 x 380	6,40	56	45,4	approx. 310

tongue&groove edge's panels

Thickness mm	Size mm	Real surface mm	kg/m ²	panels/pallet	m ² /panels	kg/pallet
40	1200 x 380	1186 x 366	16,00	22	24,8	approx. 420
60	1200 x 380	1186 x 366	19,20	18	20,3	approx. 420

Technical characteristics

Characteristics	Values
Manufacturing controlled according to the standard	UNI EN 13171
Identification code	WF - EN 13171 - T4 - CS(10 \ Y)50 - TR2,5 - AF,100
Density kg/m ³	160
Reaction to fire according to the standard EN 13501-1	E
Coefficient of thermal conductivity λ_D W/(m·K)	0,038
Specific heat J/(kg·K)	2100
Resistance to vapor diffusion μ	5
Value s_d (m)	0,2 (40) / 0,3 (60) / 0,4 (80)
Thermal resistance R_D (m ² ·K)/W	1,05 (40) / 1,55 (60) / 2,10 (80)
Compressive strenght (kPa)	50
Components	wood fibers, paraffin
Waste code (EAK)	030105/170201



Fibertherm® universal

High density wood fiber panels

Wet produced

density 270 kg/m³

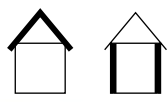

FiberTherm® universal is a thermo-acoustic insulation in wood fiber panels, particularly stable and light, fixed under the surface finishing layer of roofs and walls. Significantly increases the insulating power of wooden elements thanks to its breathable power and its remarkable density **270 kg/m³**.

It is a thermal and acoustic insulation used as a rigid panel for pitched roofs with a slope of $\geq 16^\circ$.

The panel can also be used as a wall insulation for wooden constructions in combination with ventilated facades.

With this wood fiber thermal insulation panel, internal insulation of perimeter and partition walls is ensured, both in the context of renovations and in new buildings.

It is guaranteed by constant checks carried out by external bodies which certify its high quality and, thanks to its high percentage of recycled material (**91,3%**), it fully complies with the **Minimum Environmental Criteria** and it is **CAM** certified.



Advantages

- high compressive strength;
- high safety thanks to the special tongue&groove profile which contributes to the hermetic closure of the construction without the need to use adhesive tapes or glues;
- windproof, waterproof, insulating layer;
- significantly reduces structural thermal bridges;
- protects from summer heat and provides good acoustic insulation;
- particularly permeable to vapor for high safety in building renovation;
- UDP-A type under-tile panel for roofs with inclination $\geq 16^\circ$.
- recyclable, ecological, respects the environment;
- construction material tested and authorized according to the European standards in force.

Uses in construction

- ✓ External insulation of roofs protected from bad weather, under coating or waterproofing;
- ✓ Insulation between beams, in double-layer roofs (not walkable);
- ✓ Internal insulation of the ceiling or roof (soffit);
- ✓ Internal insulation of the ceiling or floor (under the screed);
- ✓ Insulation for external walls as long as it remains covered with BetonWood cement bonded particle board or rainproof coating;
- ✓ Thermal-acoustic insulation of wooden structures (X-Lam);
- ✓ Thermal-acoustic insulation of metal frame structures;
- ✓ Insulation of internal partitions.

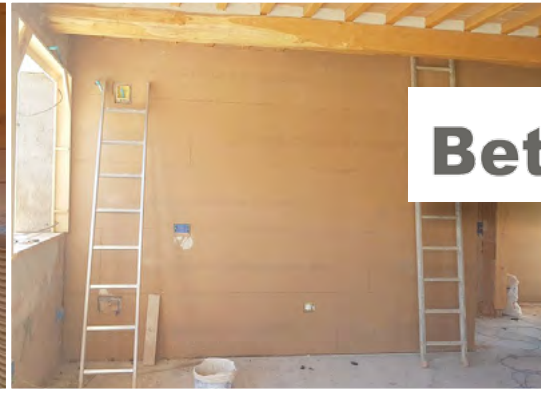

Available sizes

tongue&groove edge's panels

Thickness mm	Size mm	Real surface mm	kg/m ²	panels/pallet	m ² /panels	kg/pallet
22	2500 x 600	2480 x 580	5,83	104	156,00	approx. 1020
24	2500 x 600	2480 x 580	6,36	98	147,00	approx. 1020
35	2500 x 600	2475 x 575	9,28	66	99,00	approx. 1010
52	2500 x 600	2475 x 575	13,78	44	66,00	approx. 1000
60	2500 x 600	2475 x 575	16,20	38	57,00	approx. 1000
35	2800 x 1250	2775 x 1225	9,28	33	115,500	approx.1130

sharp edge's panels

Thickness mm	Size mm	kg/m ²	panels/pallet	m ² /panels	kg/pallet
35	2800 x 600	9,28	33	115,500	approx.1130

Technical characteristics

Characteristics	Values
Manufacturing controlled according to the standard	EN-14964-IL
Identification code	WF-EN 13171-T5-DS(70,-)2-CS(10 \Y)200-TR30-WS1,0-AFr100
Density kg/m ³	270
Reaction to fire according to the standard EN 13501-1	E
Coefficient of thermal conductivity λ_D W/(m·K)	0,048
Specific heat J/(kg·K)	2100
Resistance to vapor diffusion μ	5
Value s_d (m)	0,11(22)/0,12(24)/0,18(35)/0,26(52)/0,30(60)
Thermal resistance R_D (m ² ·K)/W	0,45(22)/0,50(24)/0,70(35)/1,05(52)/1,25(60)
Flexural strength at 10% of compression $\bar{\sigma}_{10}$ (N/mm ²)	0,20
Compressive strenght (kPa)	200
Tensile strength perpendicular to the faces (kPa)	≥ 30
Short-term water absorption (kg/m ²)	≤ 1,0
Components	wood fibers, paraffin
Waste code (EAK)	030105 /170201

BetonTherm high performance armored thermal insulation

The BetonTherm armored thermal insulation system consists of the coupling of a milled cement bonded particle board to house the dowels and one in insulating material such as wood fiber, blond cork or polystyrene. The external insulation system is and has a high mechanical resistance to compression, noise reduction and thermal displacement superior to all other overcoats on the market.

- high resistance to abrasion and impact
- resistance to humidity and frost
- resistance to fungi and insects
- flame resistance and anti-combustion
- high thermal and acoustic insulation both in summer and in winter
- ease of processing and fastening
- long duration

Certified building material



BetonWood srl

Via di Rimaggio, 185
I-50019 Sesto Fiorentino (FI)
T: +39 055 8953144
F: +39 055 4640609
info@betonwood.com
www.betonwood.com

The indications and requirements indicated above are based on our current technical and scientific knowledge, which in any case are to be considered purely indicative, as the conditions of use are not controllable by us. Therefore, the buyer must in any case verify the suitability of the product for the specific case, assuming all responsibility for use, relieving BetonWood® from any consequent claim for damages.

For any information, contact our sales department at:

info@betonwood.com

SELL TERMS AND CONDITIONS: downloadable on the site www.betonwood.com